

DIME (2.3g) WEIGHT HOLDER

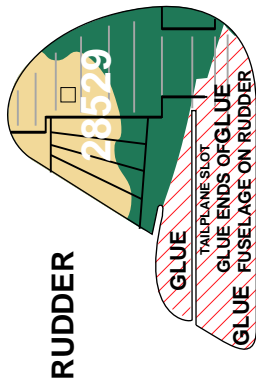

RUDDER

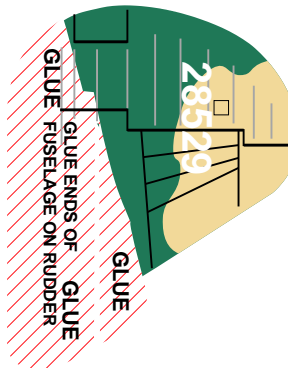
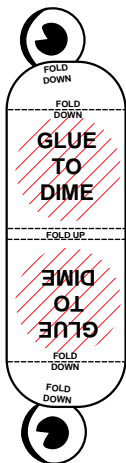
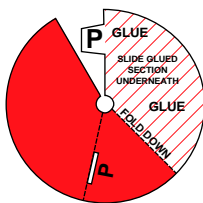

OUTSIDE CONE

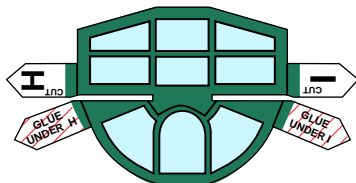

COCKPIT COVER

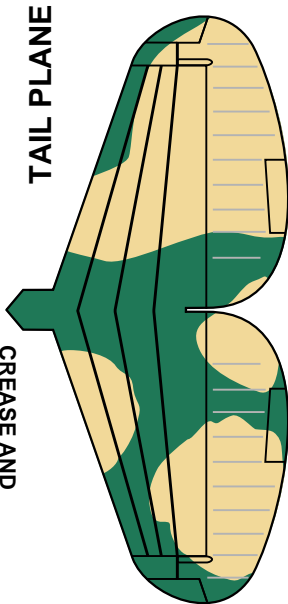
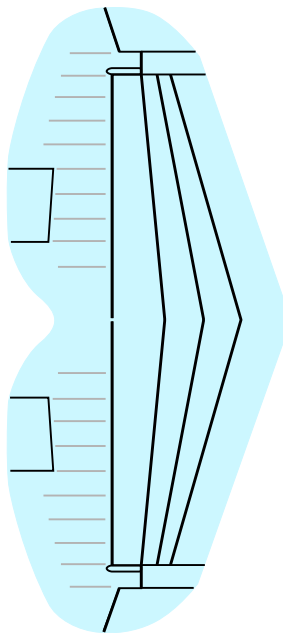

TAIL PLANE

Released For Personal Use Only
All Commercial Rights Reserved
PKAeronaut@aol.com



WWII FLYING TIGERS P-40
DIME-WEIGHT FLYING MODEL
Copyright © 1993/1994 FLY'N THINGS™



WWIII FLYING TIGERS P-40
DIME-WEIGHT FLYING MODEL
Copyright © 1993/1995 FLY'N THINGS™

Released For Personal Use Only
All Commercial Rights Reserved
PKAeronaut@aol.com

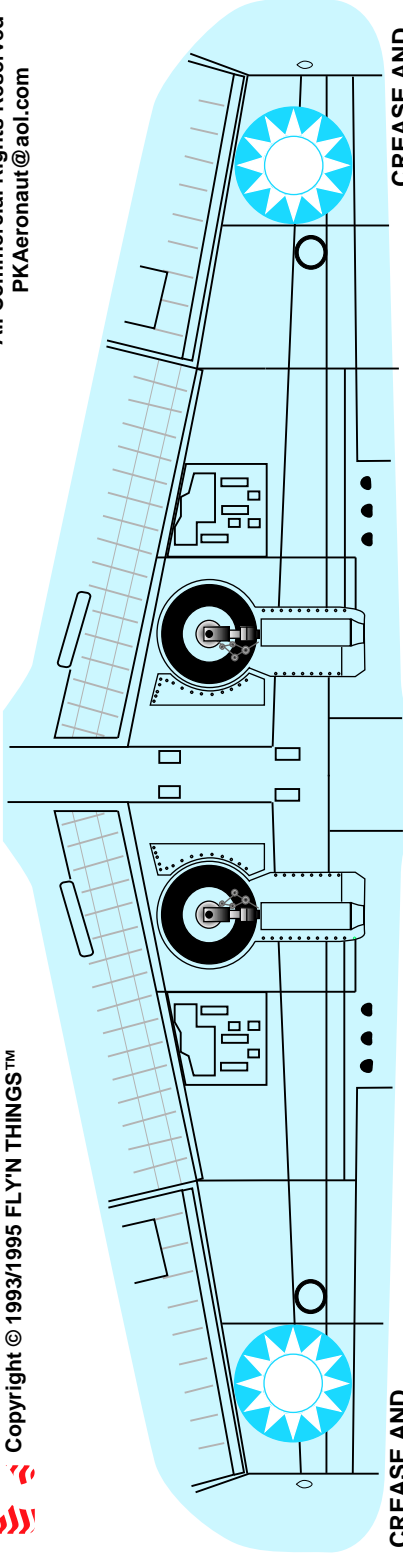

CREASE AND
FOLD UNDER

CREASE AND
FOLD UNDER

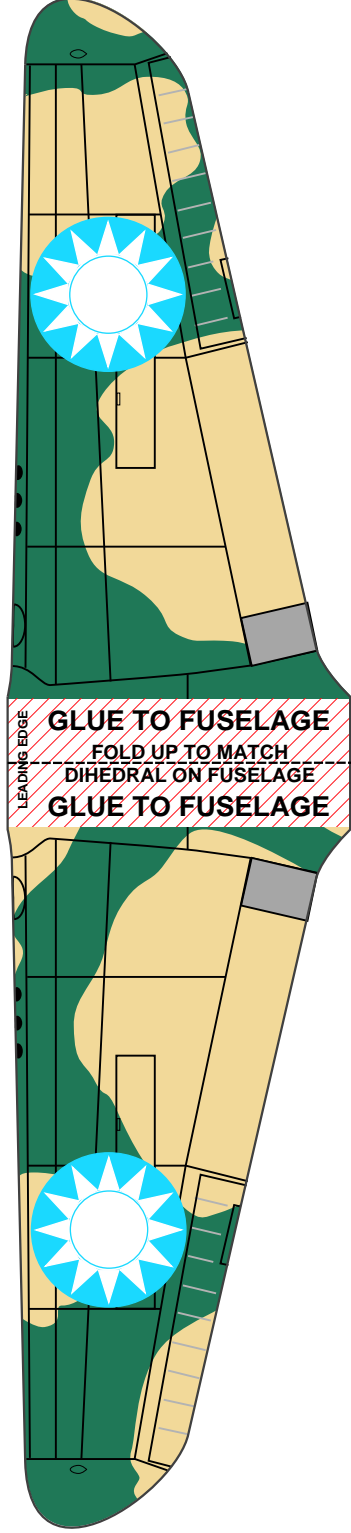

LEADING EDGE
GLUE TO FUSELAGE
FOLD UP TO MATCH
DIHEDRAL ON FUSELAGE
GLUE TO FUSELAGE

WING

WWII JAPANESE ZERO
 DIME-WEIGHT FLYING MODEL PLANE
 Copyright © 1992/1994 FLY'N THINGS™

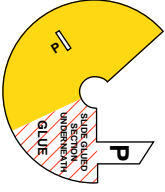

**OUTSIDE
 CONE**

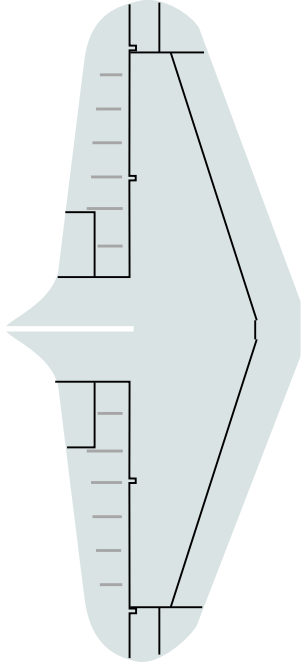

GREASE AND
 FOLD UNDER

GREASE AND
 FOLD UNDER

TAILPLANE

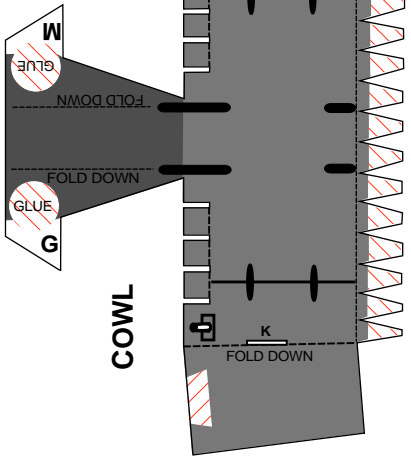
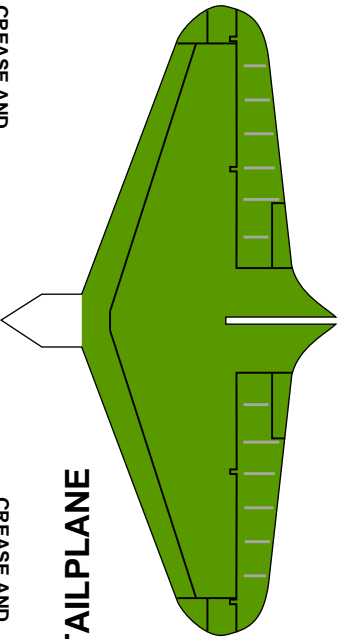

COWL



**INSIDE
 CONE**

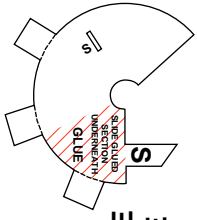

Released For Personal Use Only
 All Commercial Rights Reserved
 PKAeronaut@aol.com

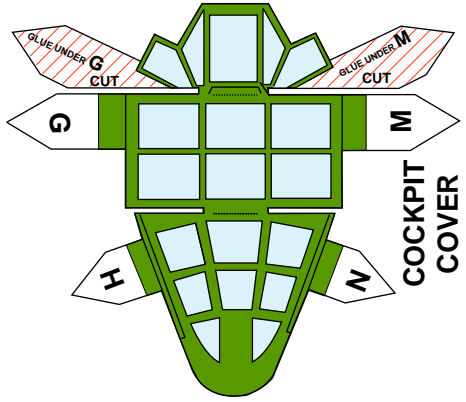

**COCKPIT
 COVER**

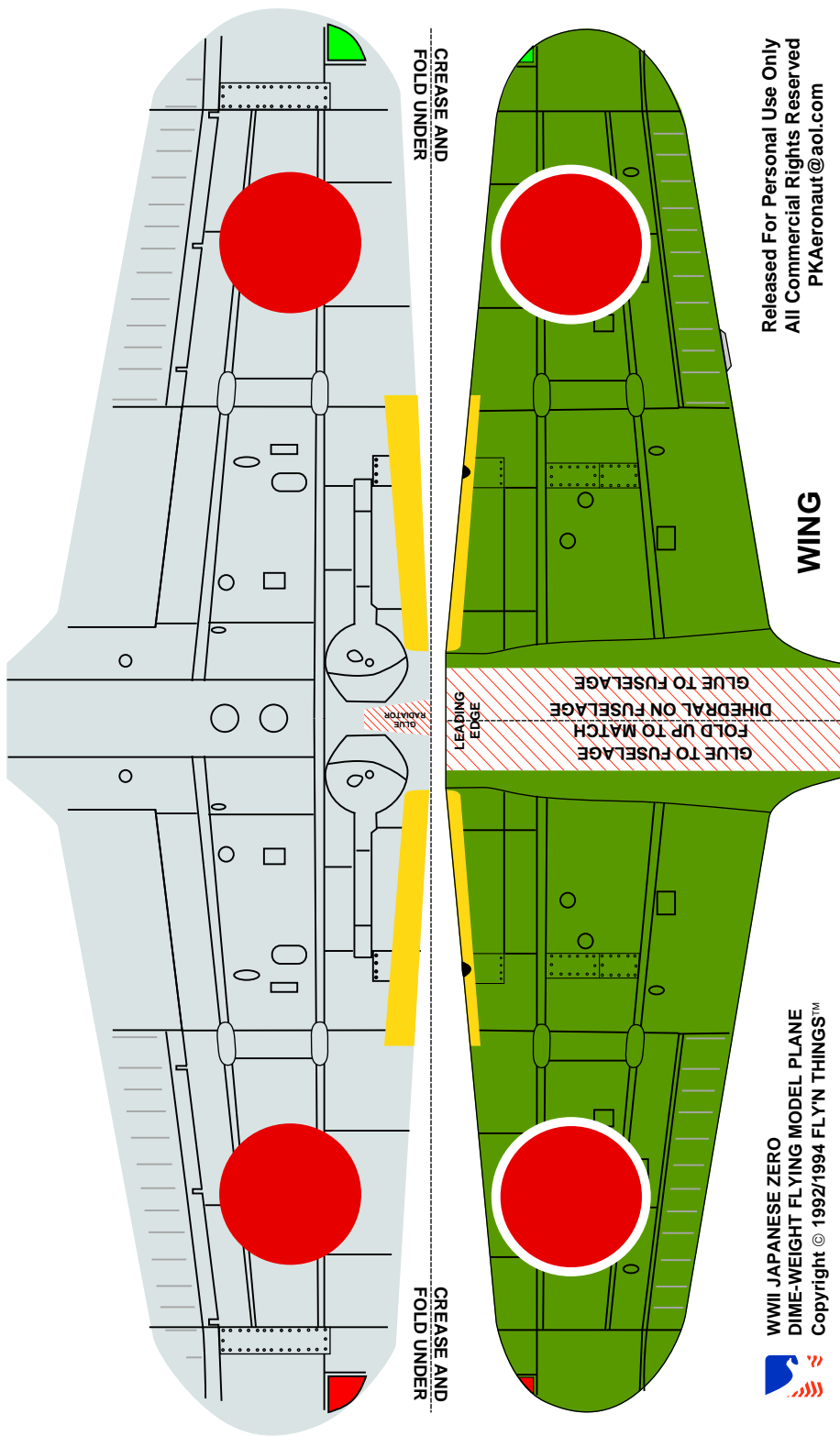

CREASE AND
FOLD UNDER

CREASE AND
FOLD UNDER

Released For Personal Use Only
All Commercial Rights Reserved
PKAeronaut@aol.com

WING

GLUE TO FUSELAGE
DIBEDRAL ON FUSELAGE
FOLD UP TO MATCH
GLUE TO FUSELAGE

LEADING
EDGE

GLUE
RADIATOR

WWI JAPANESE ZERO
DIME-WEIGHT FLYING MODEL PLANE
Copyright © 1992/1994 FLY'N THINGS™



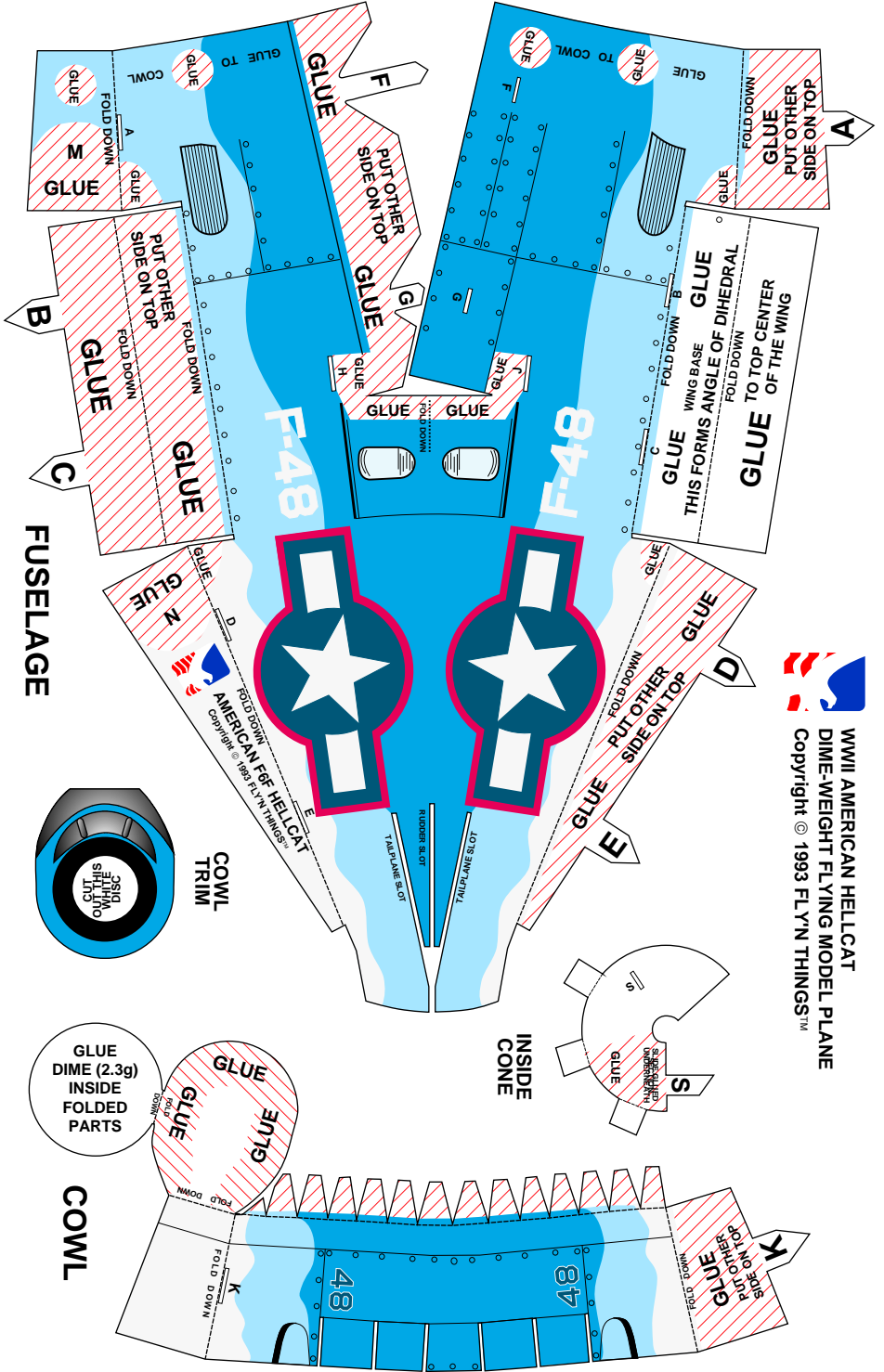

FUSELAGE



GLUE
DIME (2.3g)
INSIDE
FOLDED
PARTS

COWL



WWI AMERICAN HELLCAT
DIME-WEIGHT FLYING MODEL PLANE
Copyright © 1993 FLY'N THINGS™



WWII AMERICAN HELLCAT
 DIME-WEIGHT FLYING MODEL PLANE
 Copyright © 1993 FLY'N THINGS™

RUDDER

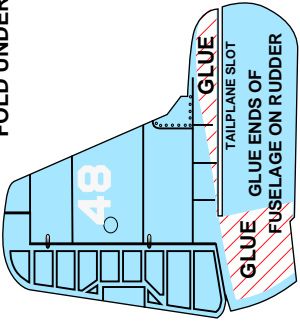

CREASE AND
 FOLD UNDER

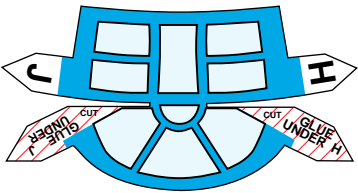
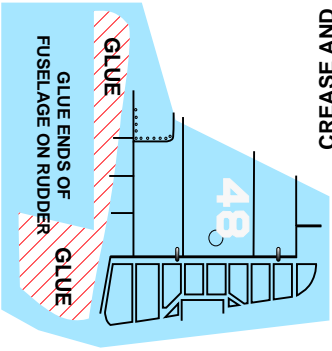

COCKPIT
 COVER

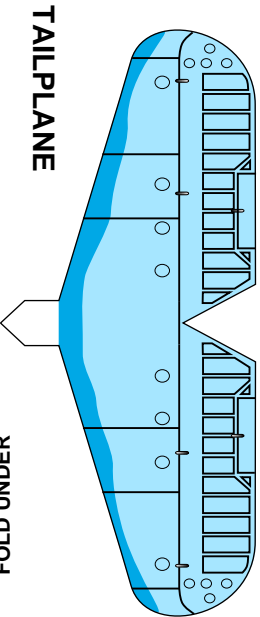
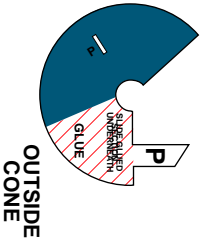

TAILPLANE

CREASE AND
 FOLD UNDER

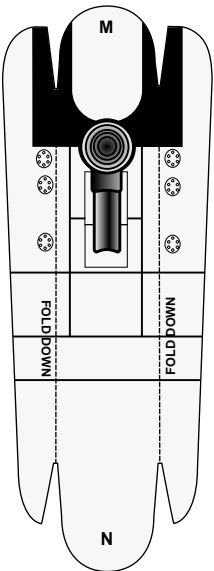
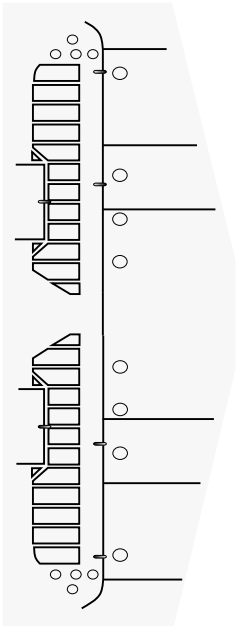

BELLY SECTION



WWI AMERICAN HELLCAT
DIME-WEIGHT FLYING MODEL PLANE
Copyright © 1993 FLY'N THINGS™

WING

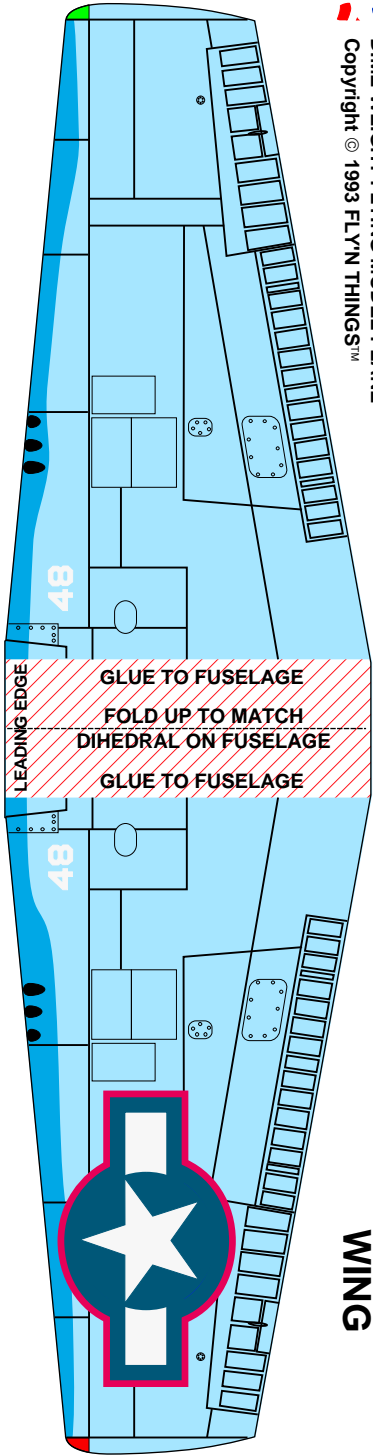

CREASE AND
FOLD UNDER

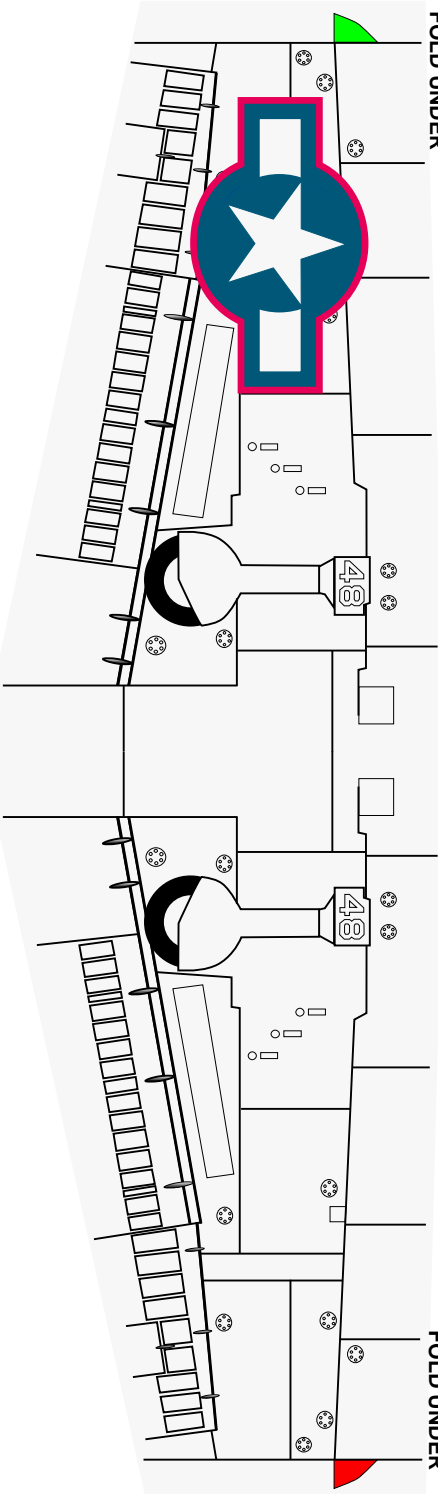

CREASE AND
FOLD UNDER

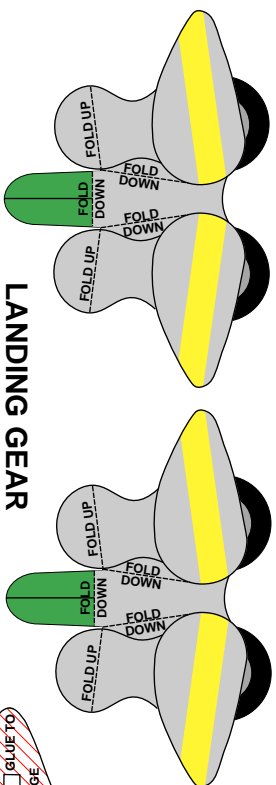

LANDING GEAR

Released For Personal Use Only
 All Commercial Rights Reserved
 PKAeronaut@aol.com

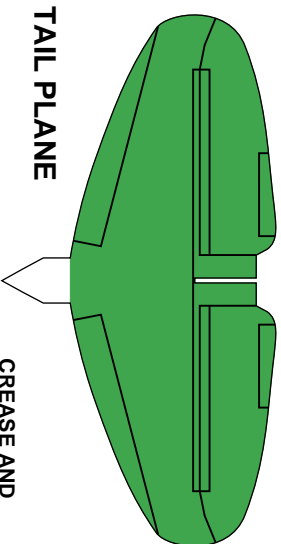

TAIL PLANE

CREASE AND
 FOLD UNDER

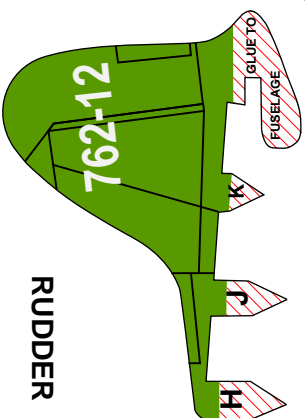
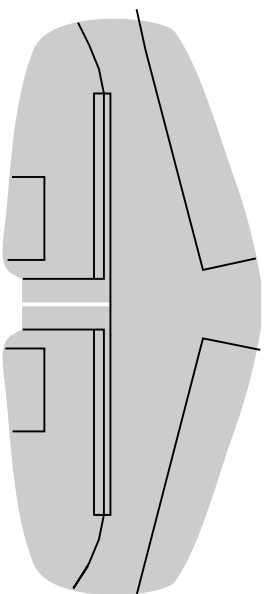

RUDDER

CREASE AND
 FOLD UNDER

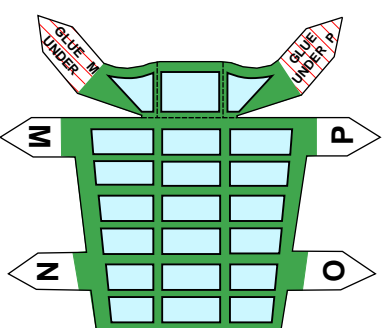
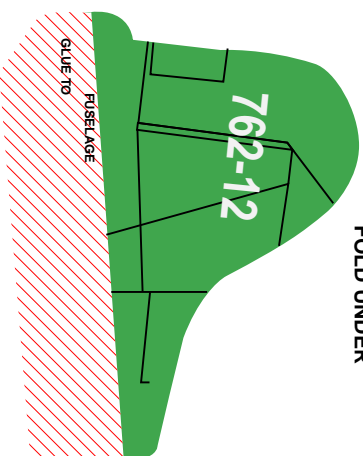

COCKPIT COVER



COWL TRIM



WW II JAPANESE AICHI "VAL " 1992-2
 DIME-WEIGHT FLYING MODEL PLANE
 Copyright © 1992/1995 FLY'N THINGS™



WWII JAPANESE AICHI "VAL" T99-2
DIME-WEIGHT FLYING MODEL PLANE
Copyright © 1992/1995 FLY'N THINGS™

WING

Released For Personal Use Only
All Commercial Rights Reserved
PKAeronaut@aol.com

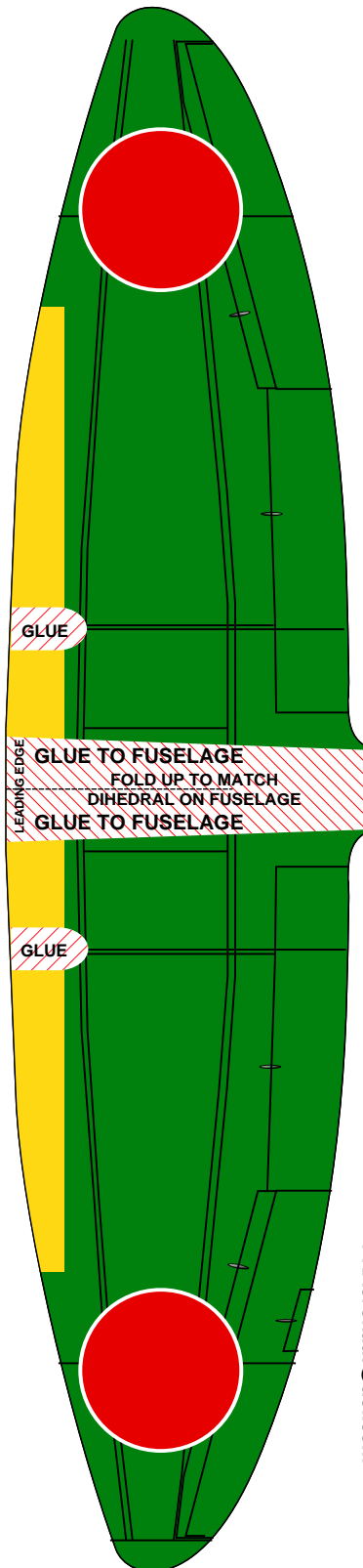

CREASE AND
FOLD UNDER

CREASE AND
FOLD UNDER

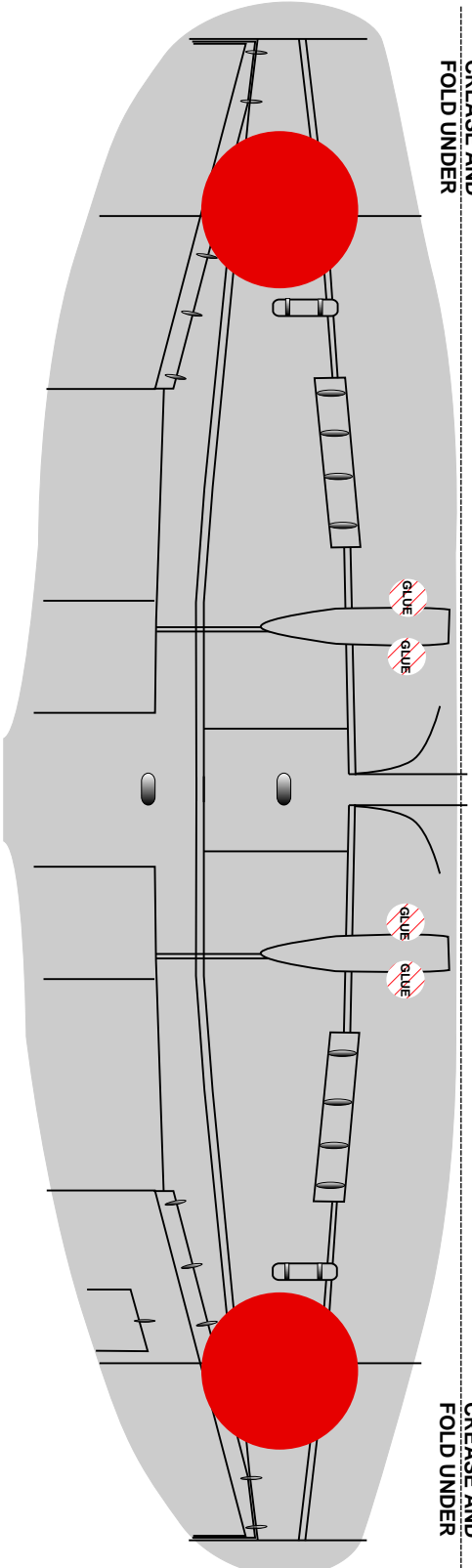

Released For Personal Use Only
 All Commercial Rights Reserved
 PKAeronaut@aol.com

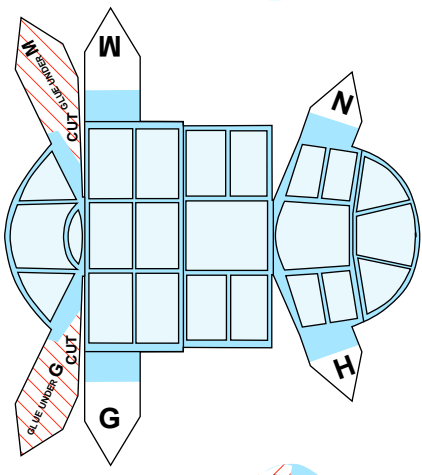

COCKPIT COVER

CREASE AND FOLD DOWN

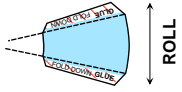

CARBURATOR AIR SCOOP

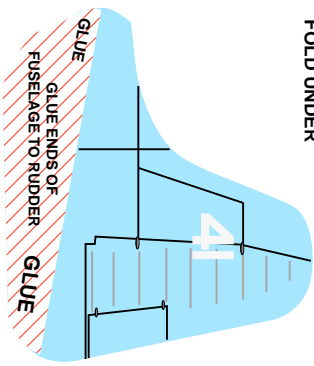

CREASE AND FOLD UNDER

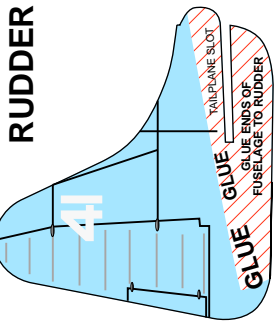

RUDDER

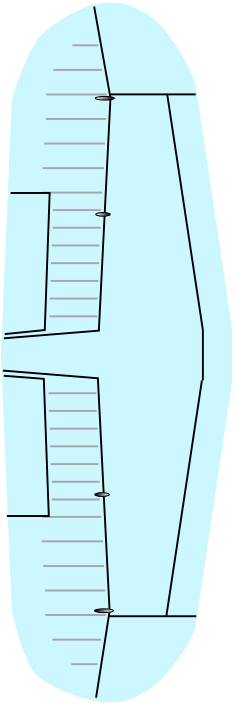

CREASE AND FOLD UNDER

CREASE AND FOLD UNDER

TAIL PLANE

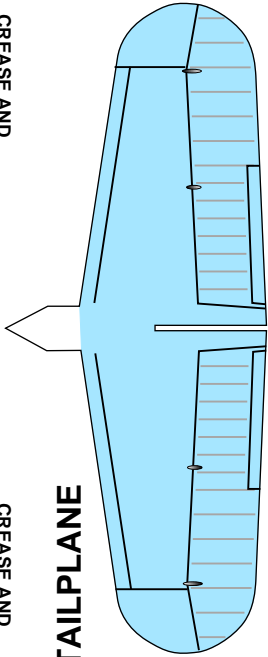

 WWII AMERICAN SBD DAUNTLESS
 DIME-WEIGHT FLYING MODEL PLANE
 Copyright © 1993/94 FLY'N THINGS™

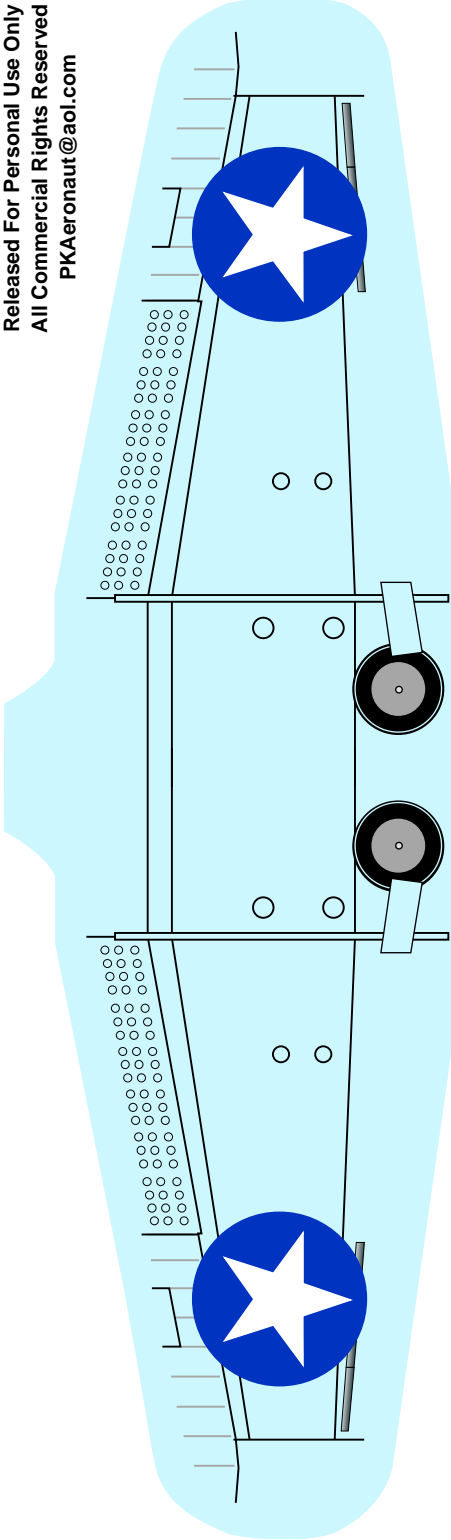

CREASE AND
FOLD UNDER

CREASE AND
FOLD UNDER

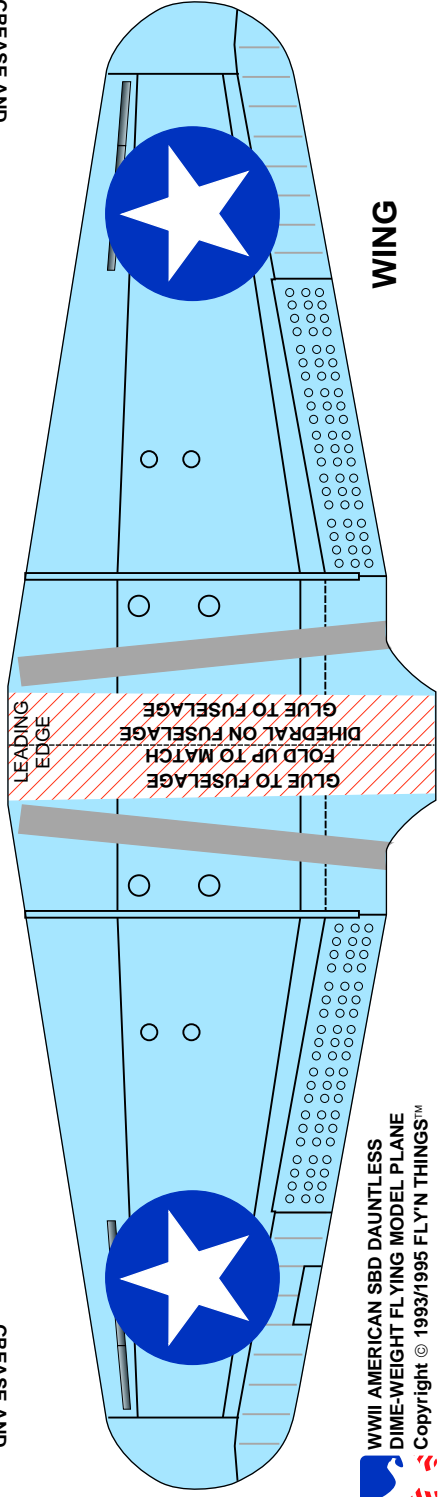

WING

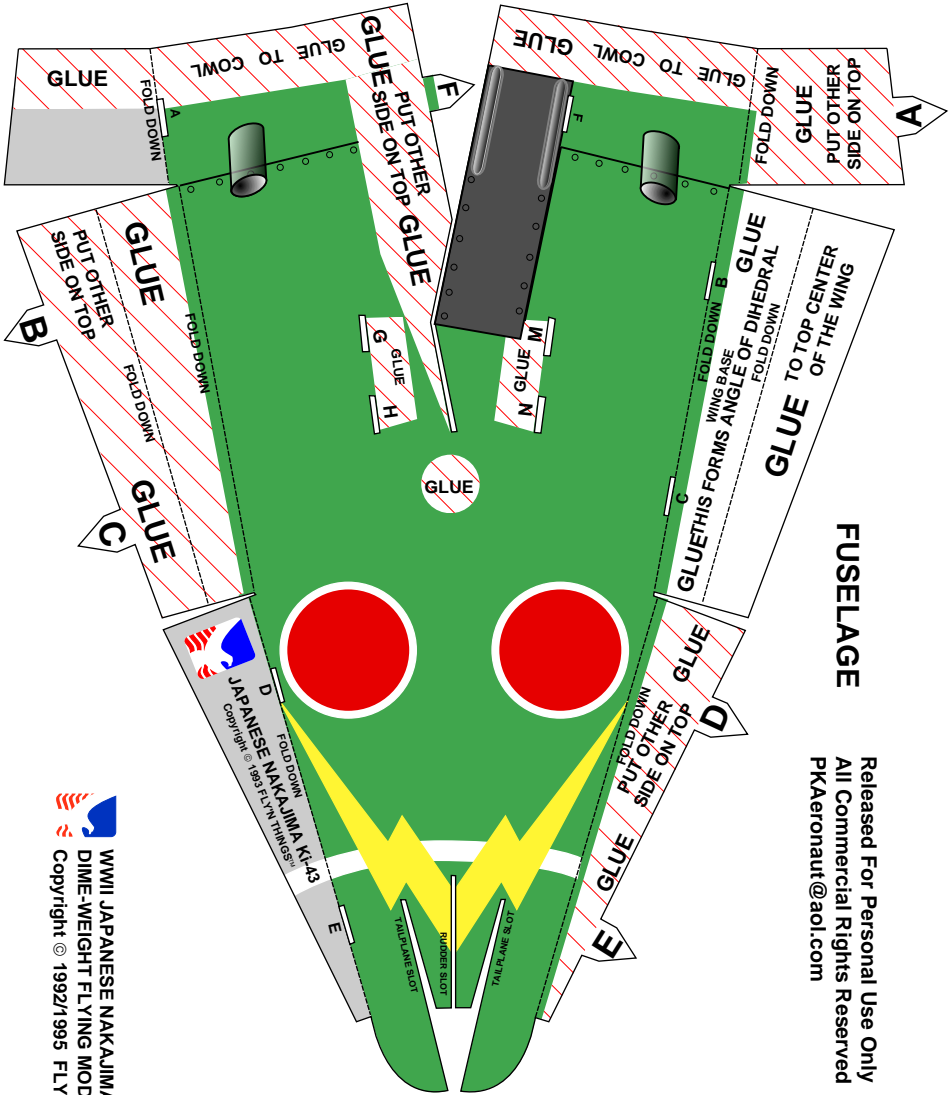

FUSELAGE

Released For Personal Use Only
 All Commercial Rights Reserved
 PKAeronaut@aol.com

WWI JAPANESE NAKAJIMA OSCAR KI-43
 DIME-WEIGHT FLYING MODEL PLANE
 Copyright © 1992/1995 FLY'N THINGS™

COWL

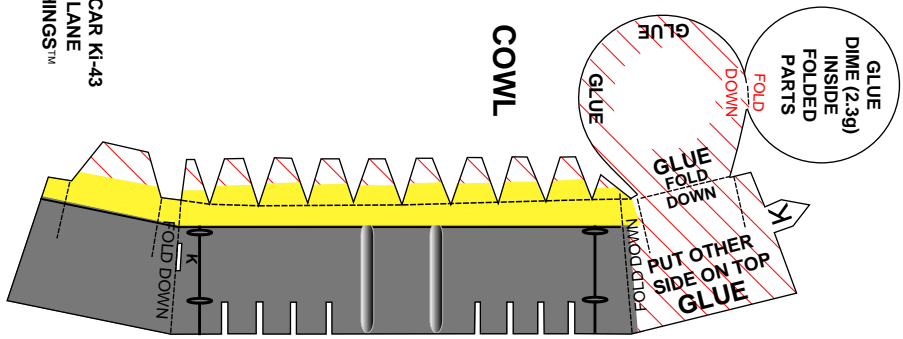

GLUE DIME (2.3g)
 INSIDE FOLDED PARTS

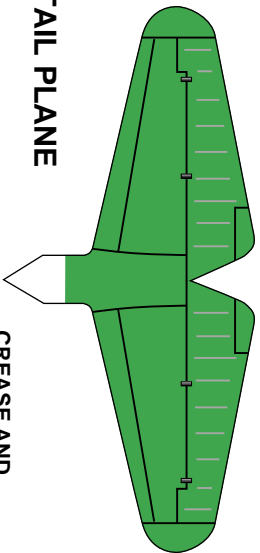

TAIL PLANE

CREASE AND
FOLD UNDER

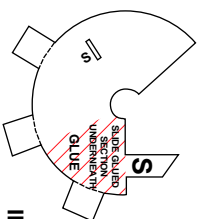
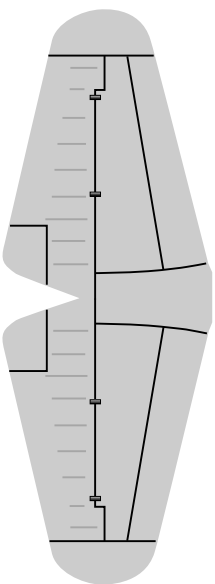

**INSIDE
CONE**

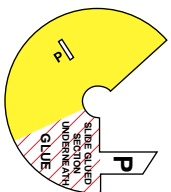

**OUTSIDE
CONE**

COCKPIT COVER

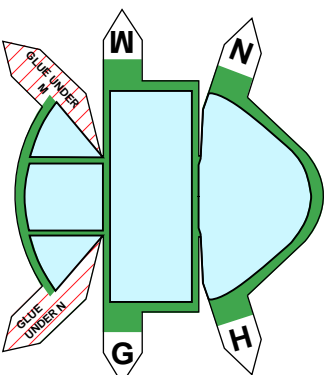

**COWL
TRIM**

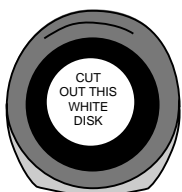

TRIM TO FINAL SIZE
AFTER ASSEMBLY
TO FRONT OF COWL

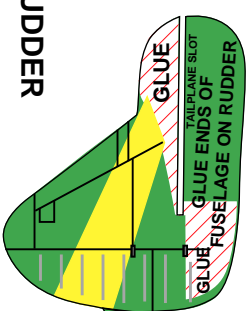

RUDDER

CREASE AND
FOLD UNDER

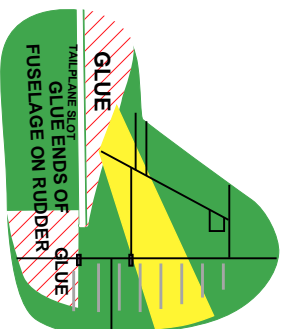

Released For Personal Use Only
All Commercial Rights Reserved
PKAeronaut@aol.com



WWII JAPANESE NAKAJIMA OSCAR KI-43
DIME-WEIGHT FLYING MODEL PLANE
Copyright © 1992/1995 FLY'N THINGS™

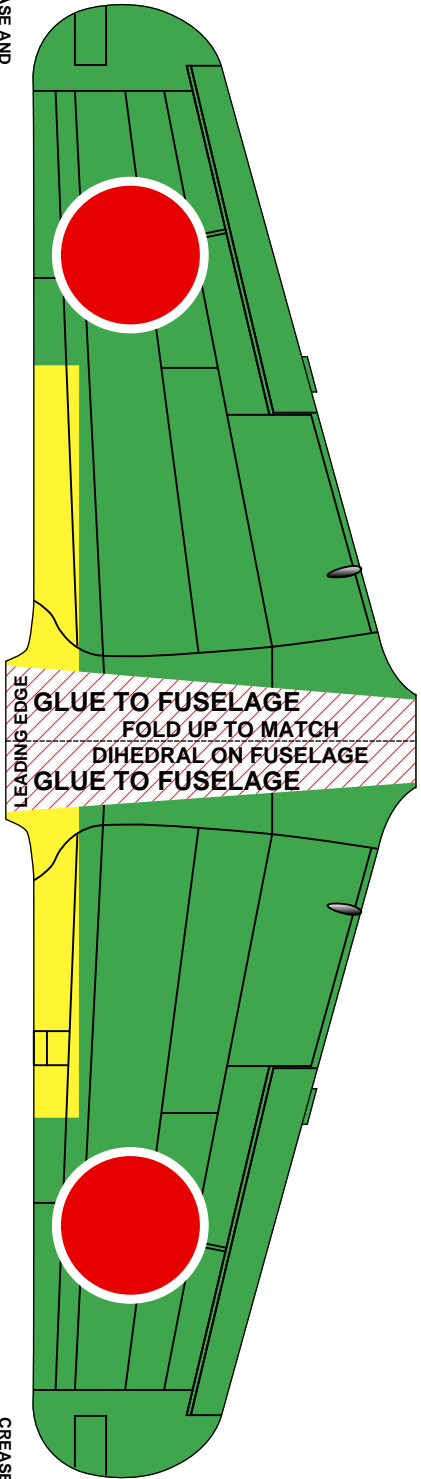

CREASE AND
FOLD UNDER

CREASE AND
FOLD UNDER

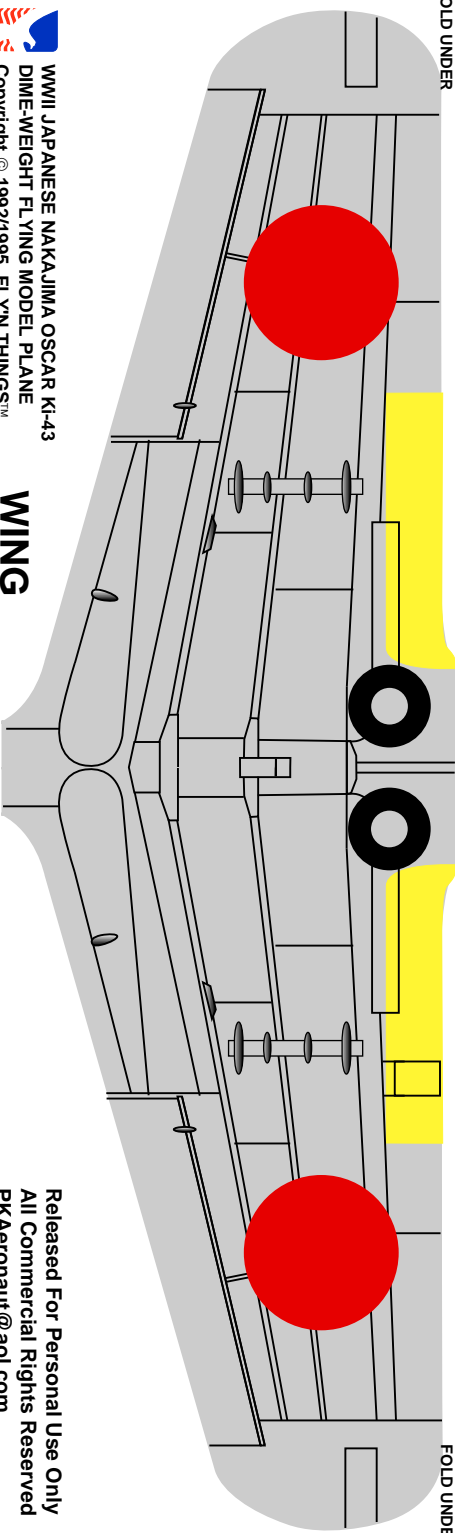

WWJ JAPANESE NAKAJIMA OSCAR KI-43
DIME-WEIGHT FLYING MODEL PLANE
Copyright © 1992/1995 FLY'N THINGS™

WING

Released For Personal Use Only
All Commercial Rights Reserved
PKaeronaut@aol.com

RADIATOR COWLING

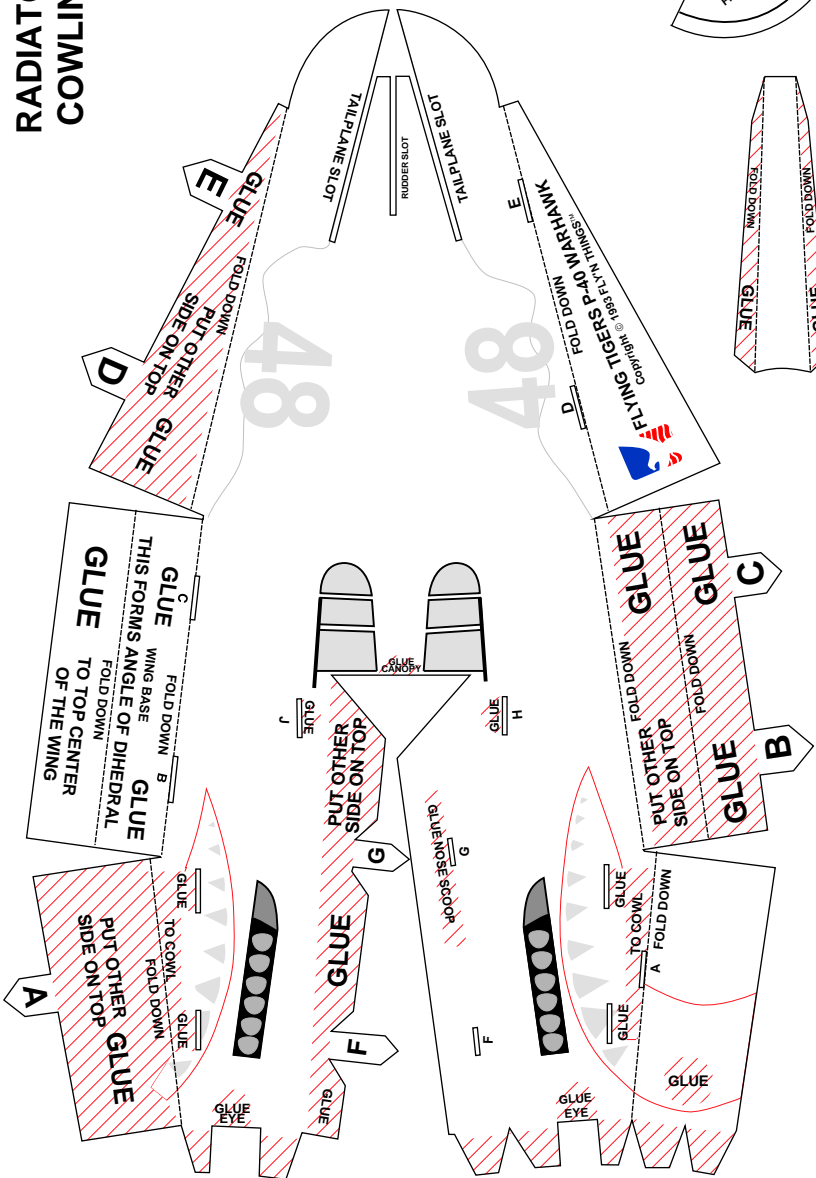
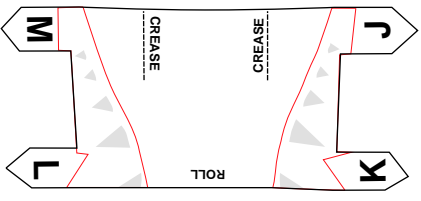

NOSE SCOOP

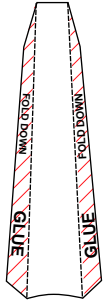

FUSELAGE

INSIDE CONE

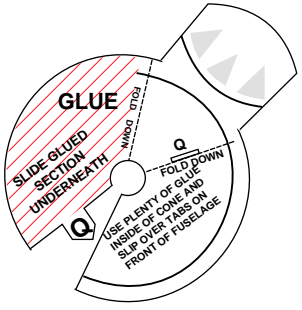

WWII FLYING TIGERS P-40
 DIME-WEIGHT FLYING MODEL
 Copyright © 1993/1995 FLY'N THINGS™

Released For Personal Use Only
 All Commercial Rights Reserved
 PKAeronaut@aol.com

48



FLYING TIGERS P-40 WARHAWK

Copyright © 1993/1995 FLY'N THINGS™

Released For Personal Use Only
 All Commercial Rights Reserved
 PKAeronaut@aol.com

DIME (2.3g) WEIGHT HOLDER

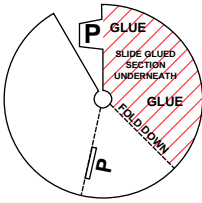
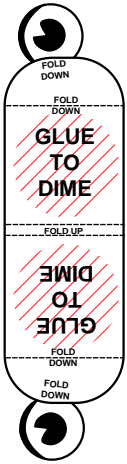

OUTSIDE CONE

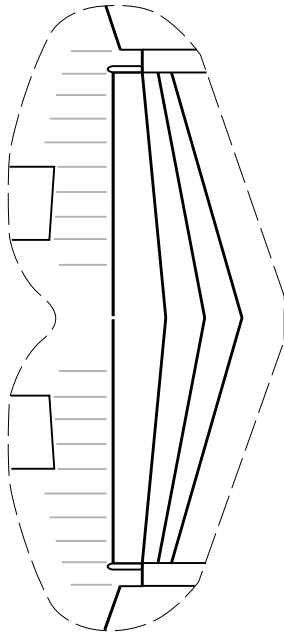

CREASE AND
 FOLD UNDER

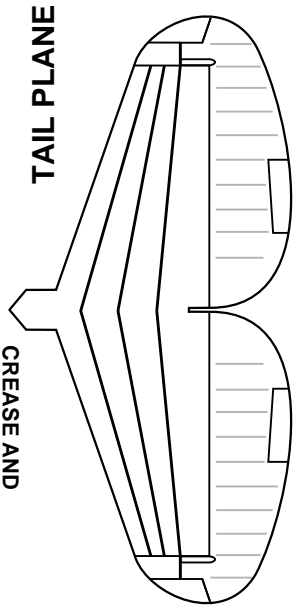

TAIL PLANE

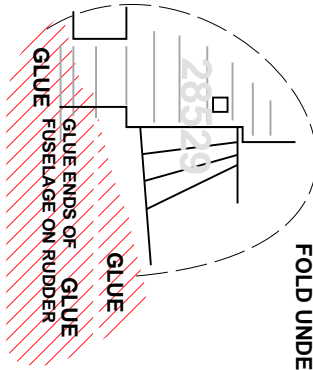

CREASE AND
 FOLD UNDER

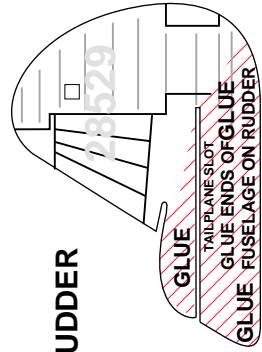

RUDDER

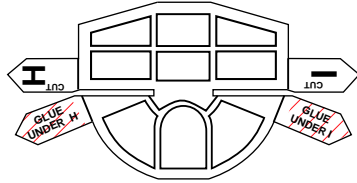

COCKPIT COVER



WWII FLYING TIGERS P-40
 DIME-WEIGHT FLYING MODEL
 Copyright © 1993/1994 FLY'N THINGS™



WWIII FLYING TIGERS P-40
DIME-WEIGHT FLYING MODEL
Copyright © 1993/1995 FLY'N THINGS™

Released For Personal Use Only
All Commercial Rights Reserved
PKAeronaut@aol.com

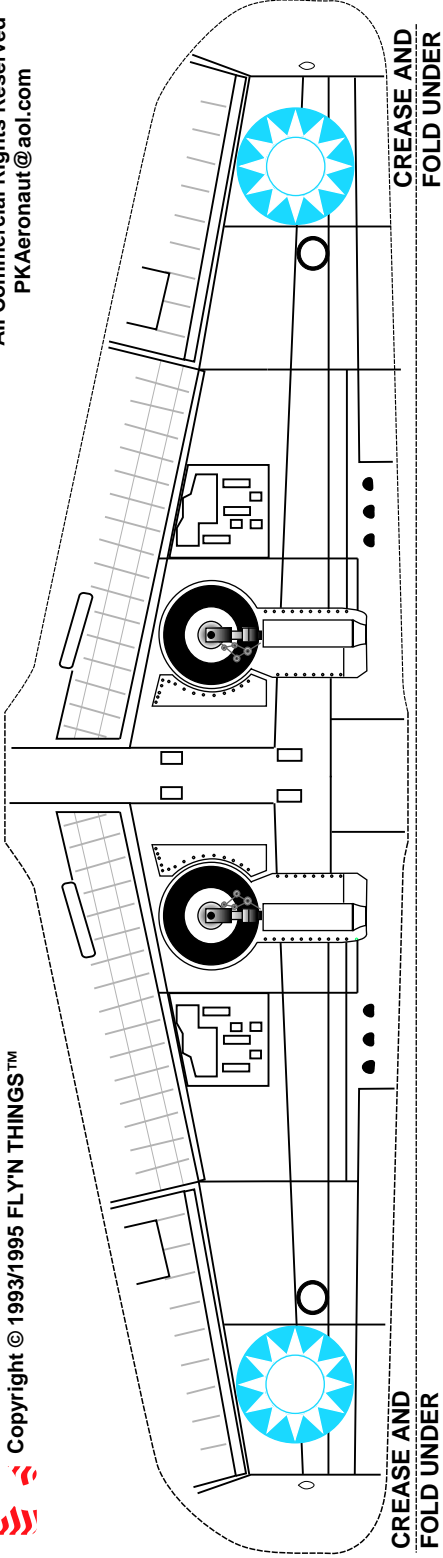

CREASE AND
FOLD UNDER

CREASE AND
FOLD UNDER

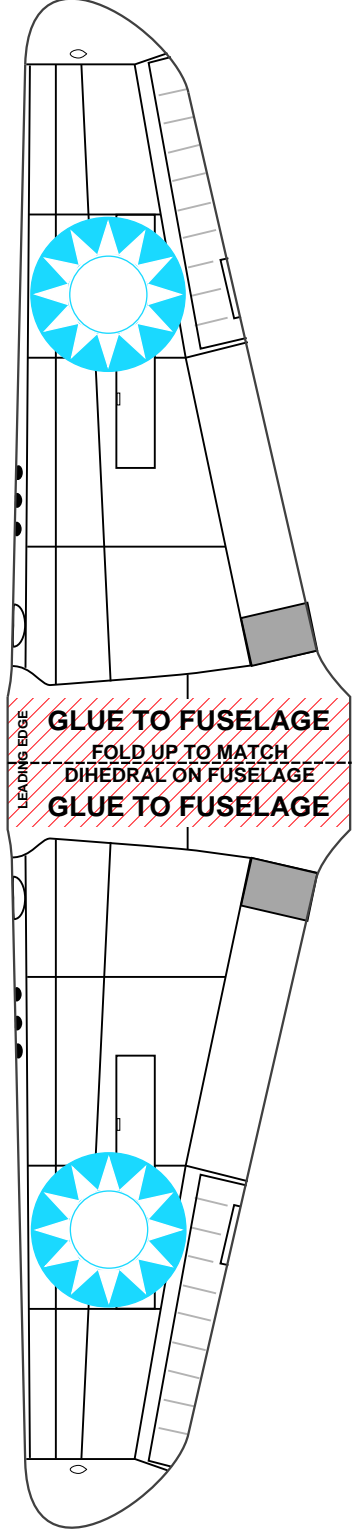

LEADING EDGE

GLUE TO FUSELAGE
FOLD UP TO MATCH
DIHEDRAL ON FUSELAGE
GLUE TO FUSELAGE

WING

WWII JAPANESE ZERO
DIME-WEIGHT FLYING MODEL PLANE
Copyright © 1992/1994 FLY'N THINGS™

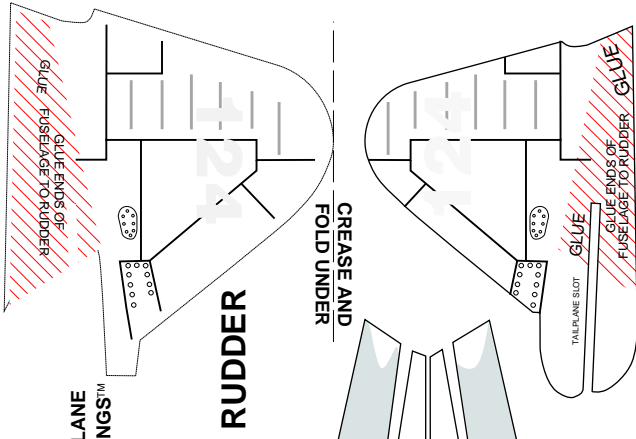

RUDDER

CREASE AND FOLD UNDER

RADIATOR

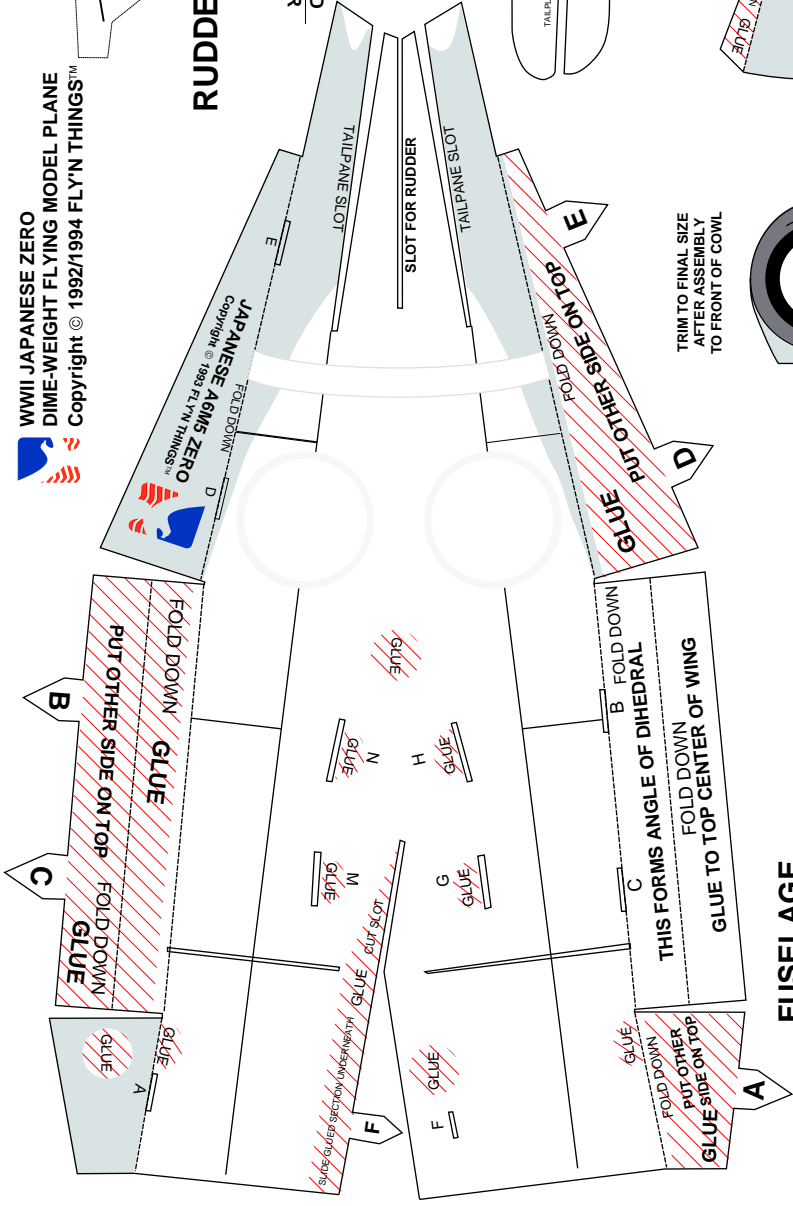
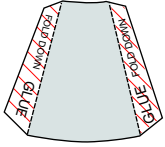

TRIM TO FINAL SIZE
AFTER ASSEMBLY
TO FRONT OF COWL



COWL TRIM

FUSELAGE

Released For Personal Use Only
All Commercial Rights Reserved
PKAeronaut@aol.com

WWII JAPANESE ZERO
 DIME-WEIGHT FLYING MODEL PLANE
 Copyright © 1992/1994 FLY'N THINGS™



Released For Personal Use Only
 All Commercial Rights Reserved
 PKAeronaut@aol.com

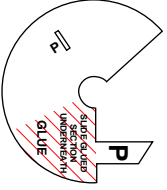

**OUTSIDE
 CONE**

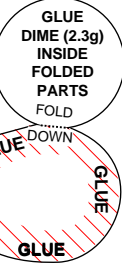
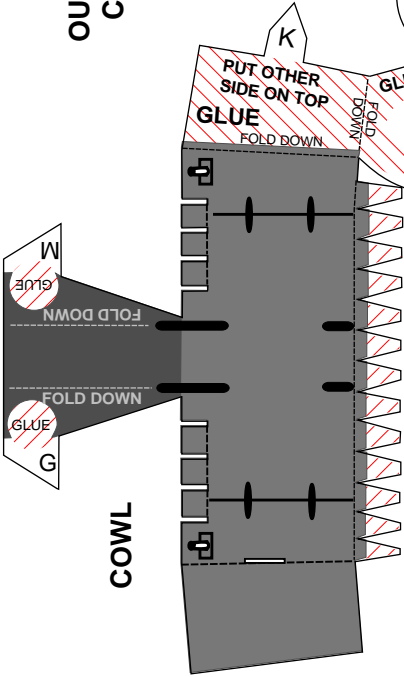

**INSIDE
 CONE**

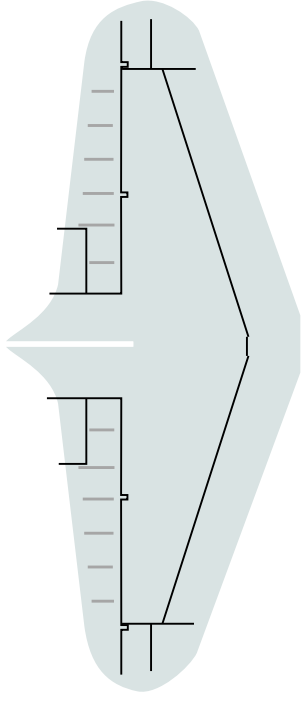
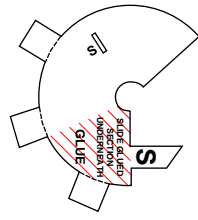

CREASE AND
 FOLD UNDER

CREASE AND
 FOLD UNDER

TAILPLANE

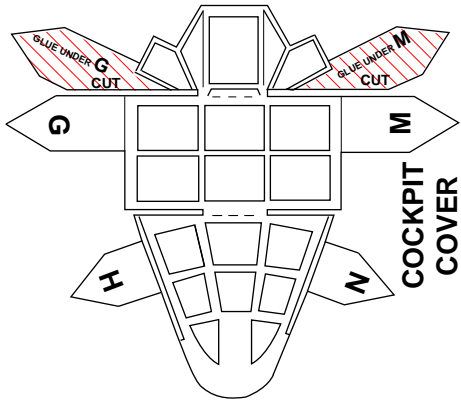
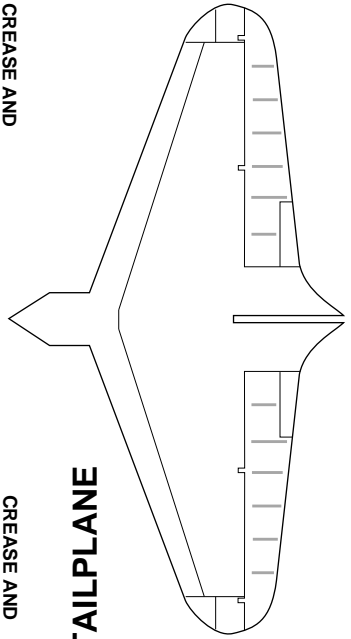

**COCKPIT
 COVER**

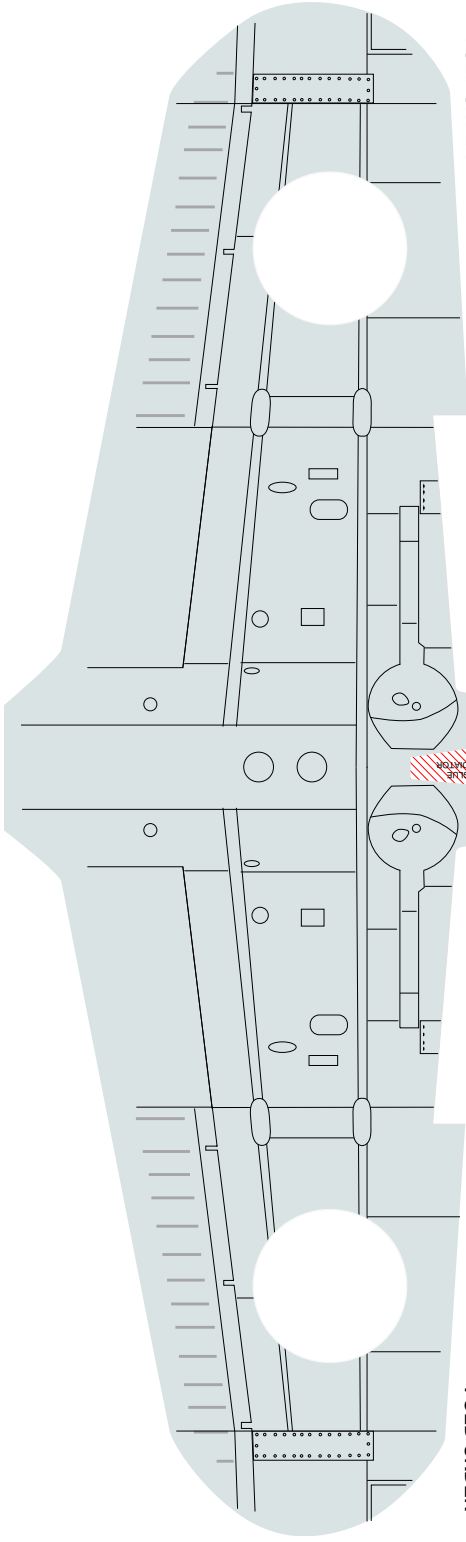

CREASE AND
FOLD UNDER

CREASE AND
FOLD UNDER

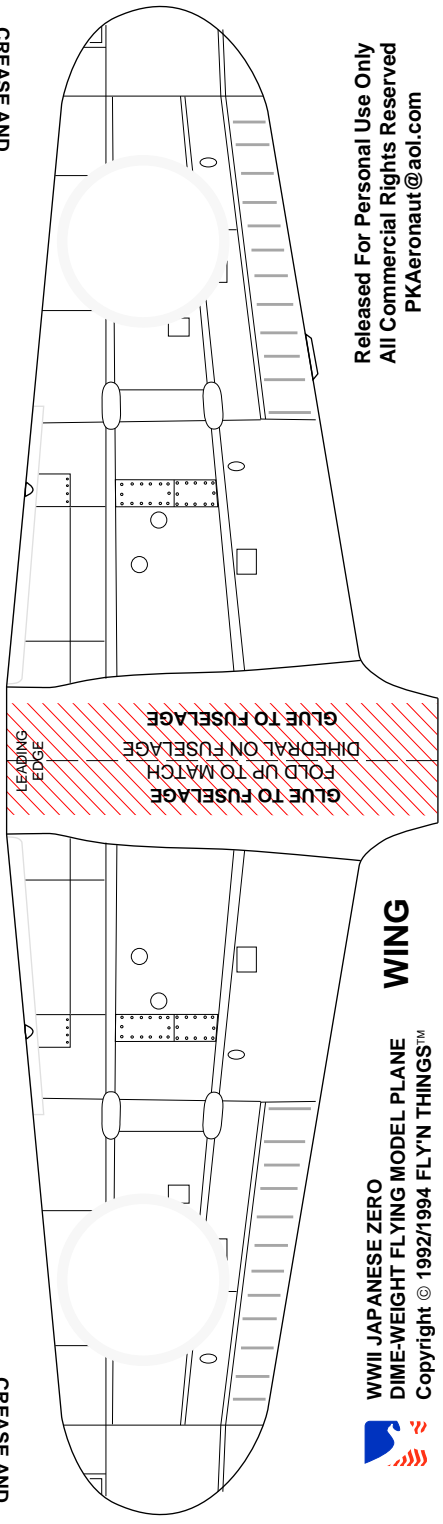

WWII JAPANESE ZERO
DIME-WEIGHT FLYING MODEL PLANE
Copyright © 1992/1994 FLY'N THINGS™

WING

Released For Personal Use Only
All Commercial Rights Reserved
PKAeronaut@aol.com

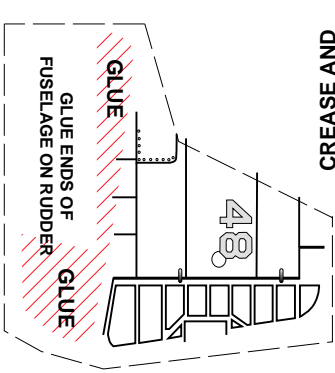

CREASE AND
FOLD UNDER

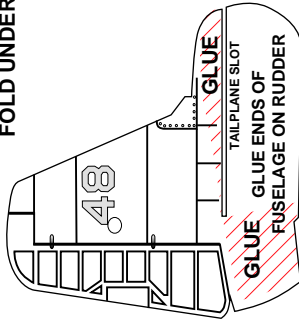

RUDDER

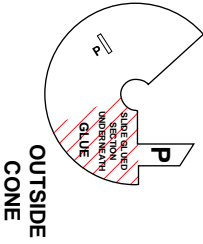

OUTSIDE
CONE

COCKPIT
COVER

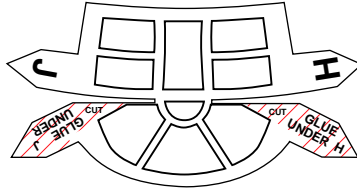

Released For Personal Use Only
All Commercial Rights Reserved
PKAeronaut@aol.com

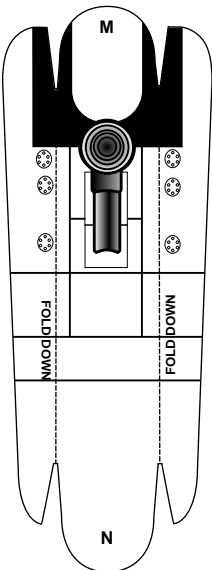

BELLY SECTION

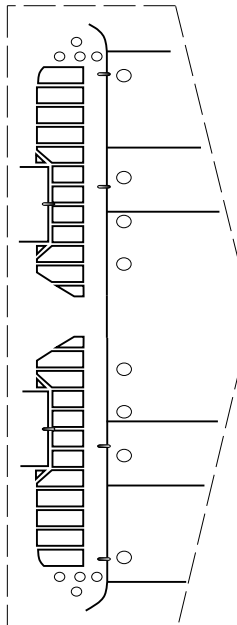

CREASE AND
FOLD UNDER

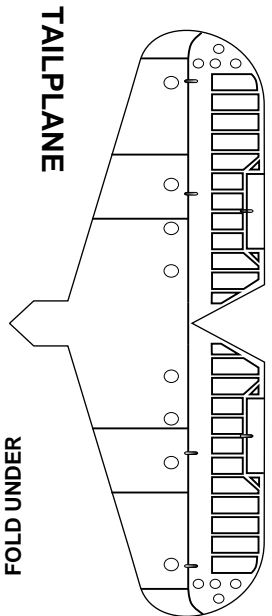

TAILPLANE



WWII AMERICAN HELLCAT
DIME-WEIGHT FLYING MODEL
Copyright © 1993/1995 FLY'N THINGS™

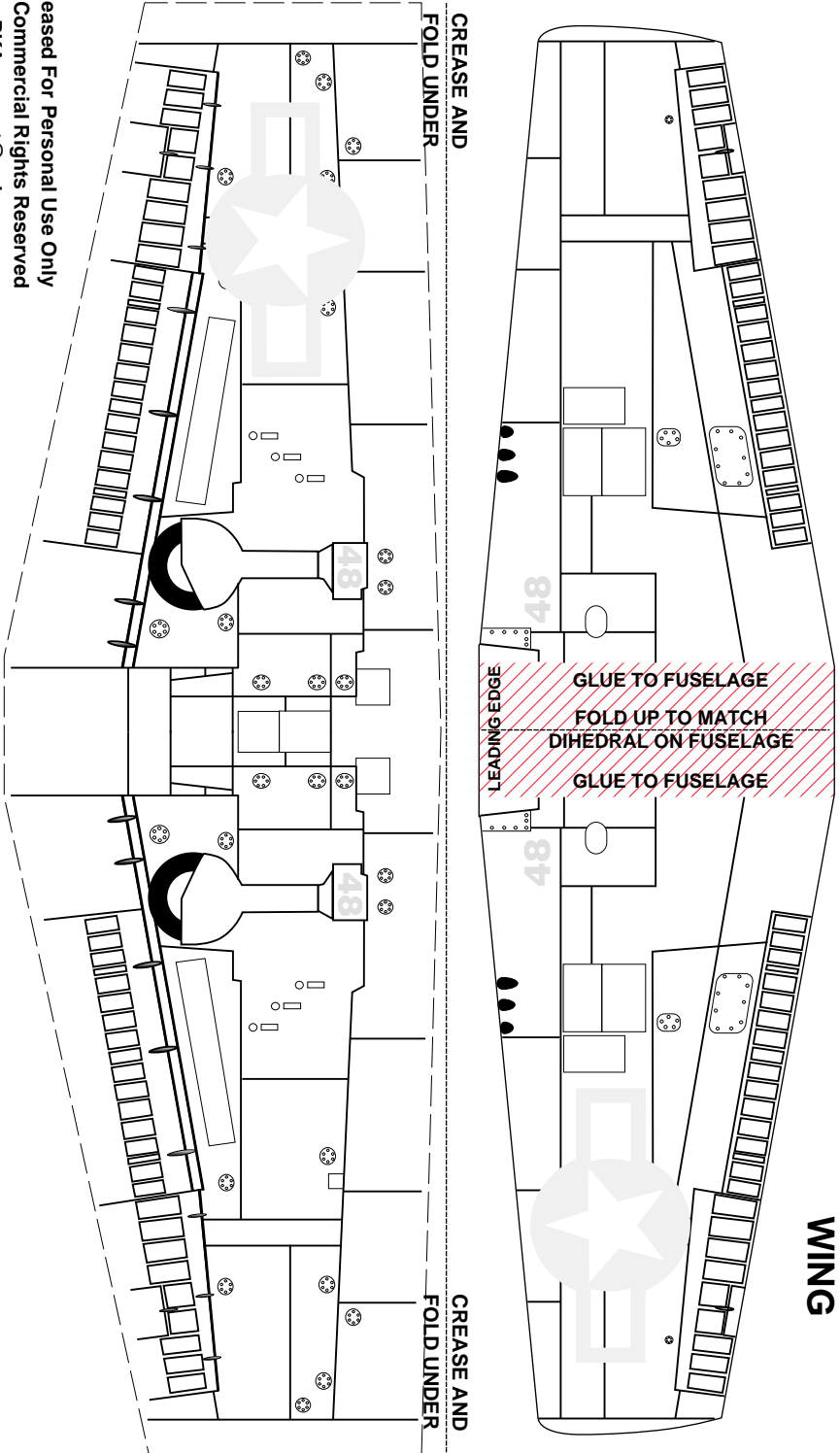

Released For Personal Use Only
All Commercial Rights Reserved
PKAeronaut@aol.com

Released For Personal Use Only
 All Commercial Rights Reserved
 PKAeronaut@aol.com

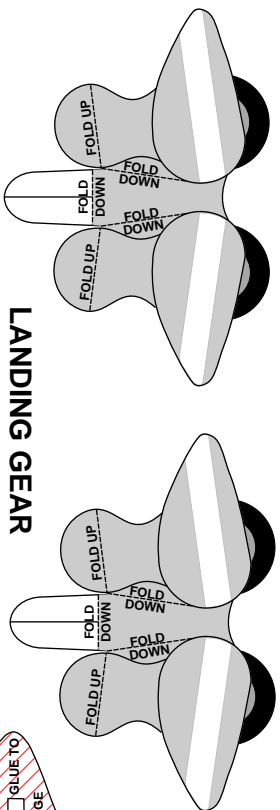

LANDING GEAR

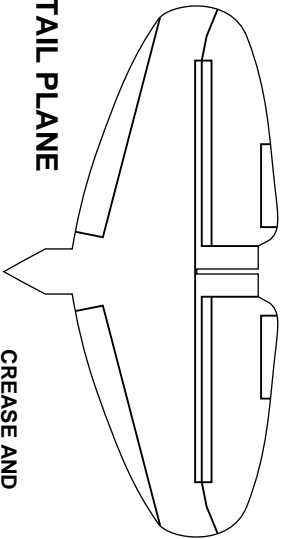

TAIL PLANE

CREASE AND
 FOLD UNDER

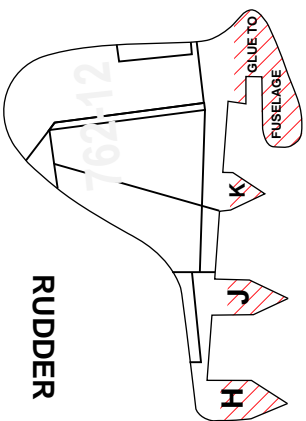
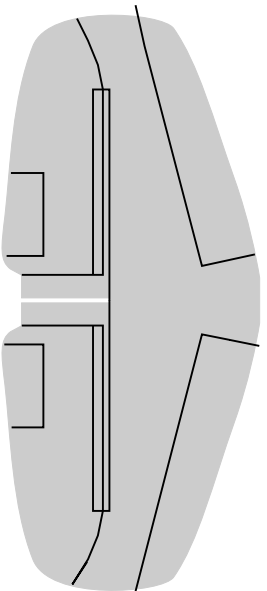

RUDDER

CREASE AND
 FOLD UNDER

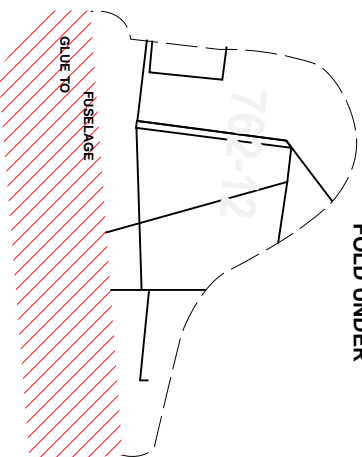

COCKPIT COVER

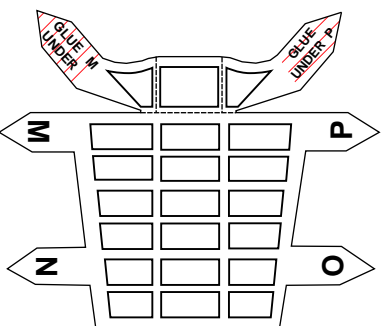

COWL TRIM



WW II JAPANESE AICHI "VAL" T99-2
 DIME-WEIGHT FLYING MODEL PLANE
 Copyright © 1992/1995 FLY'N THINGS™

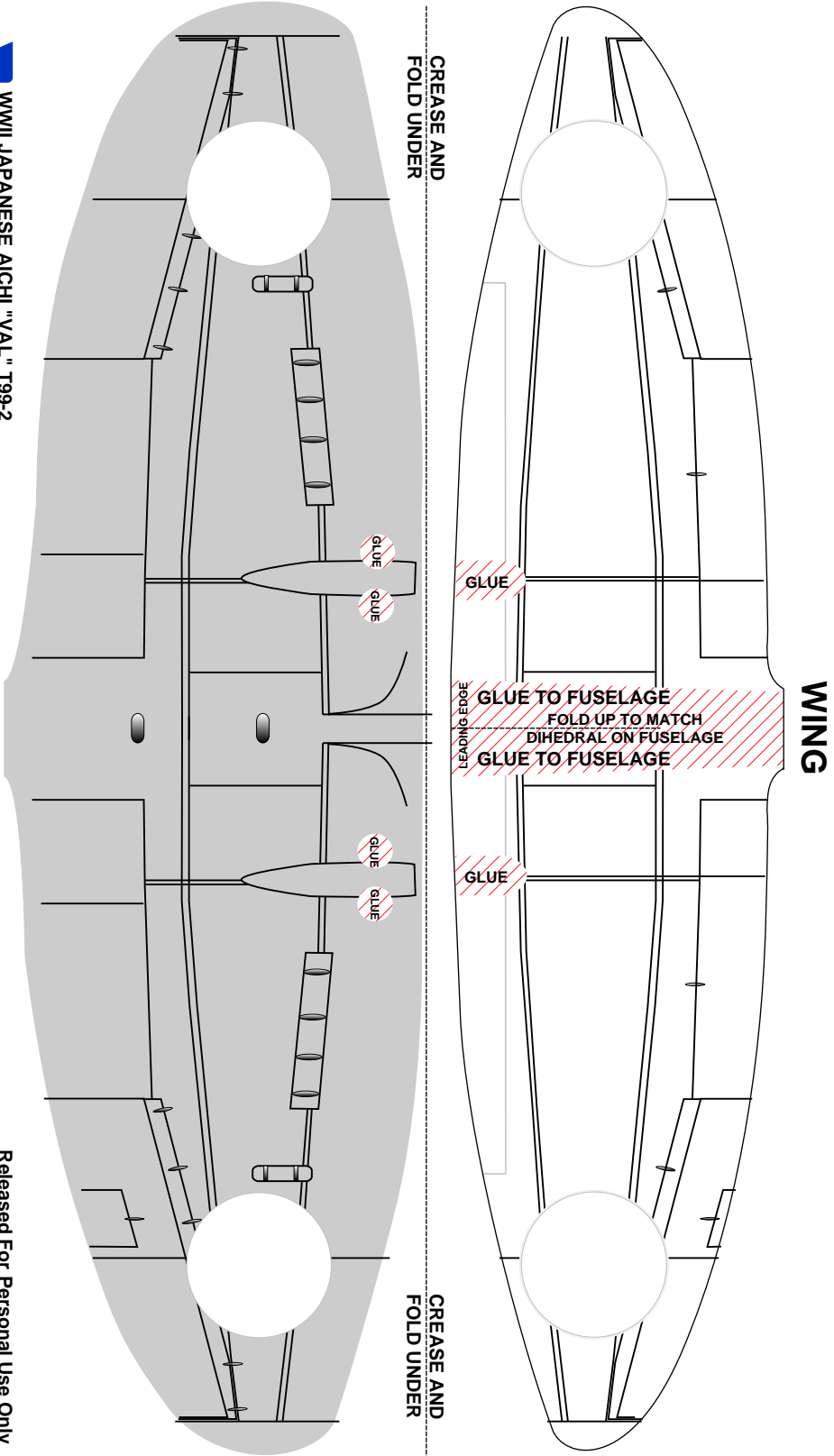

WING

**CREASE AND
FOLD UNDER**

**CREASE AND
FOLD UNDER**

GLUE

GLUE TO FUSELAGE
FOLD UP TO MATCH
DIHEDRAL ON FUSELAGE
GLUE TO FUSELAGE

LEADING EDGE

GLUE

GLUE

GLUE

Released For Personal Use Only
 All Commercial Rights Reserved
 PKAeronaut@aol.com

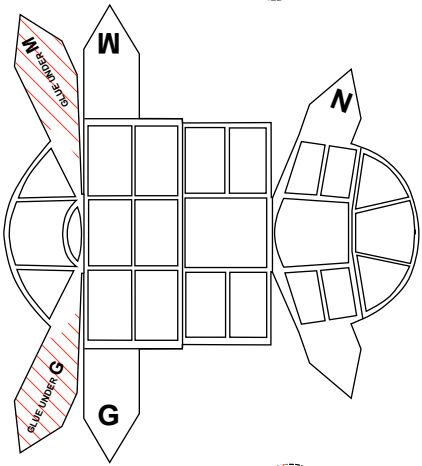

COCKPIT COVER

CREASE AND FOLD DOWN

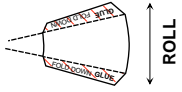

CARBURATOR AIR SCOOP

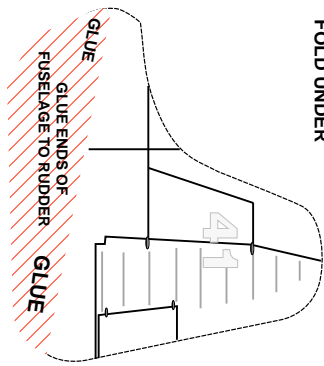

CREASE AND FOLD UNDER

RUDDER

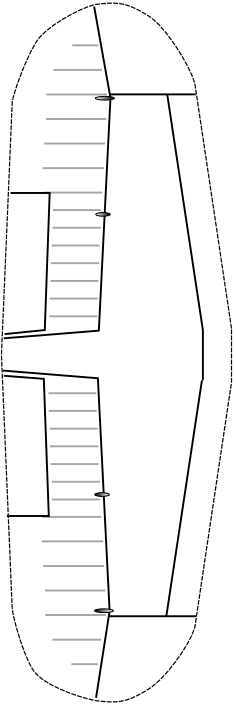
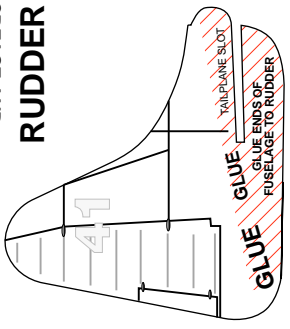

CREASE AND FOLD UNDER

CREASE AND FOLD UNDER

TAILPLANE

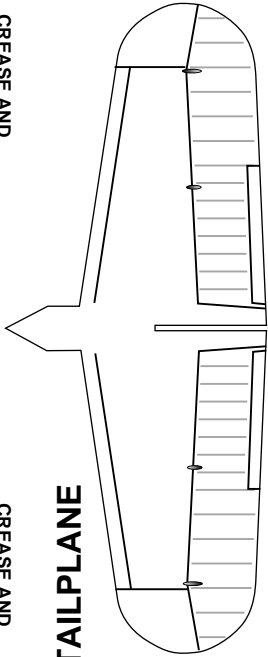

 WWII AMERICAN SBD DAUNTLESS
 DIME-WEIGHT FLYING MODEL PLANE
 Copyright © 1993/94 FLY'N THINGS™

Released For Personal Use Only
All Commercial Rights Reserved
PKAeronaut@aol.com

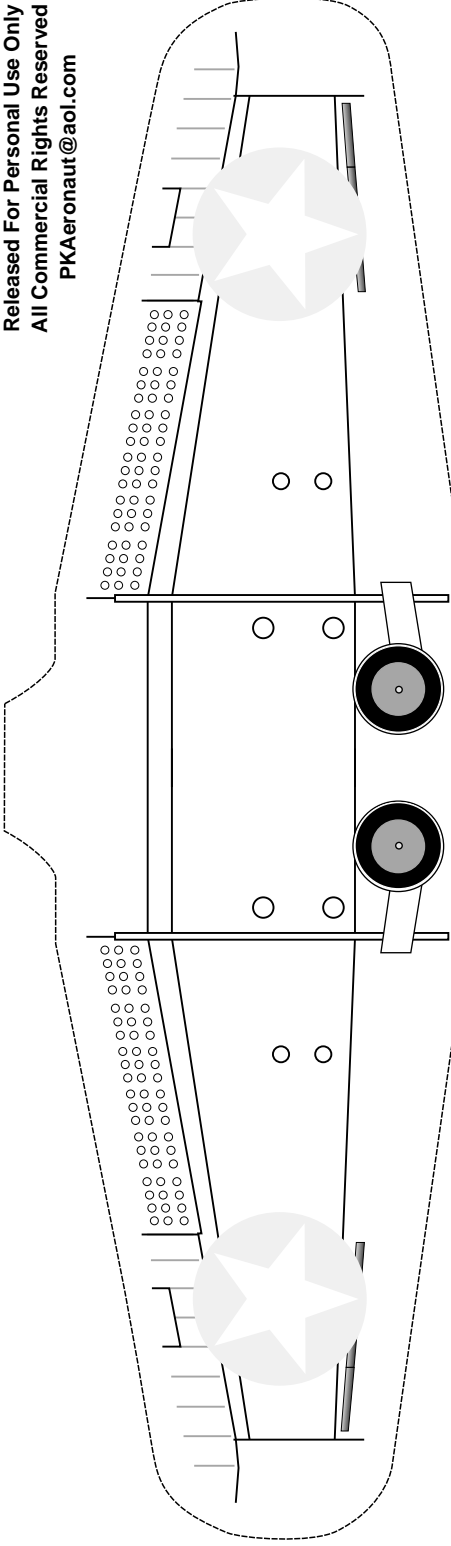

CREASE AND
FOLD UNDER

CREASE AND
FOLD UNDER

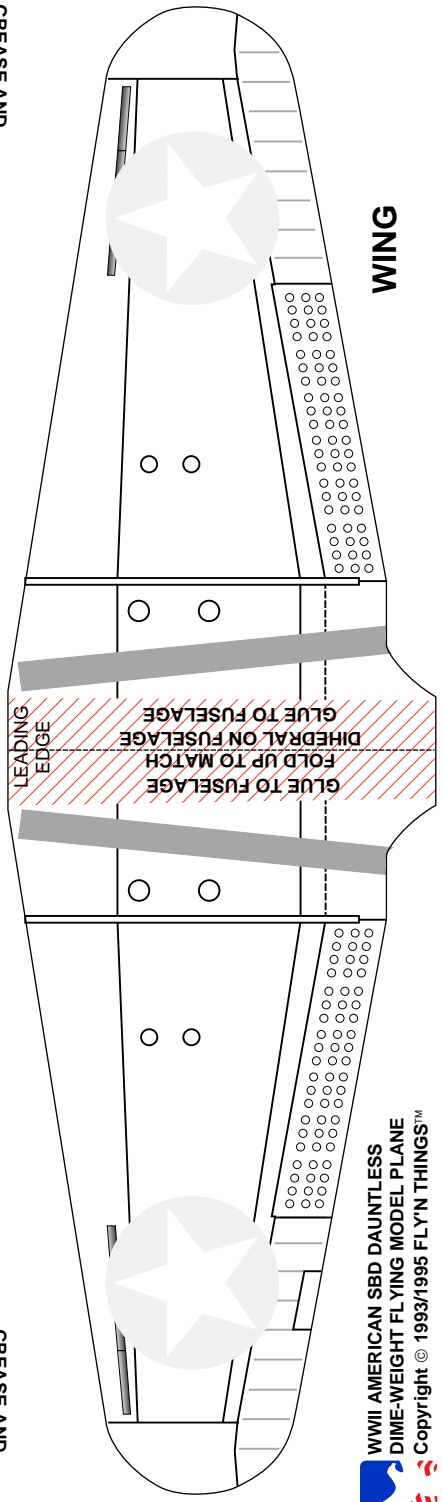

WWII AMERICAN SBD DAUNTLESS
DIME-WEIGHT FLYING MODEL PLANE
Copyright © 1993/1995 FLY'N THINGS™



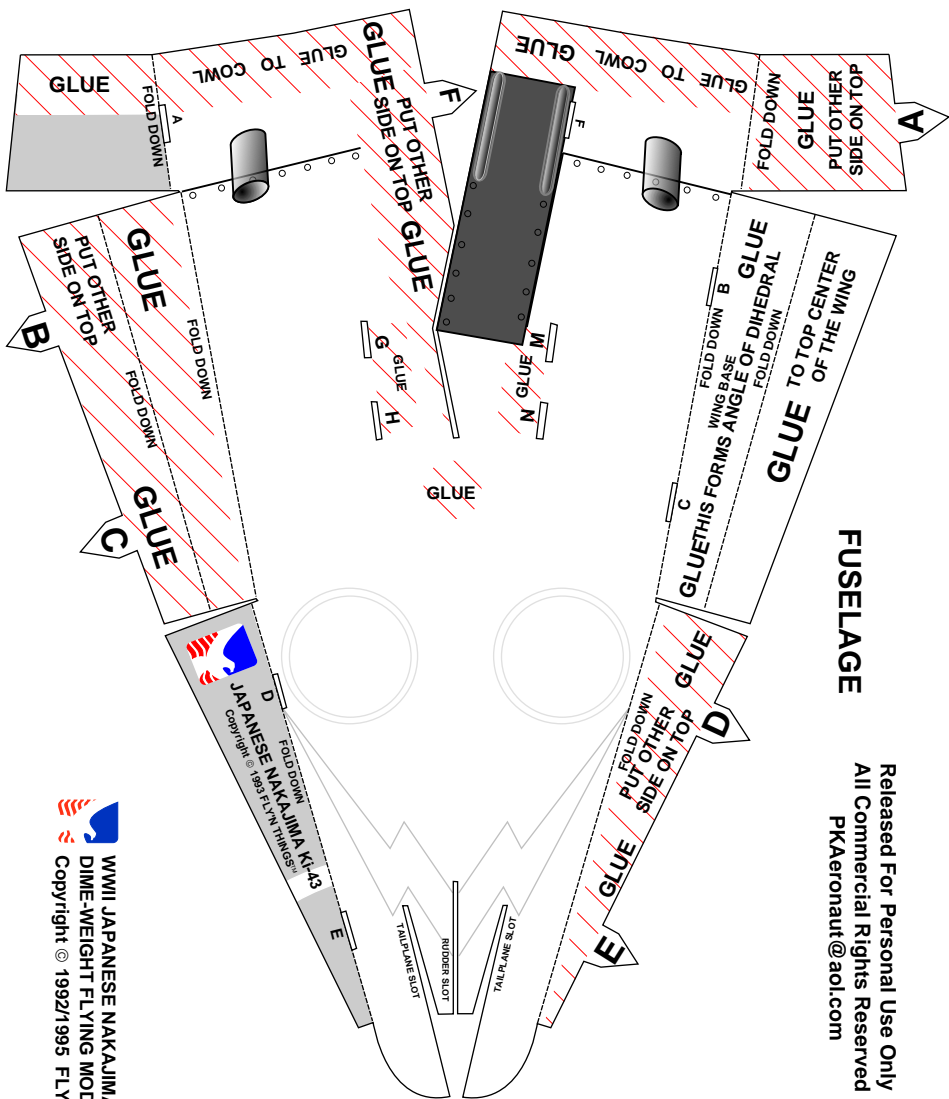

FUSELAGE

Released For Personal Use Only
 All Commercial Rights Reserved
 PKAeronaut@aol.com

WW1 JAPANESE NAKAJIMA OSCAR KI-43
 DIME-WEIGHT FLYING MODEL PLANE
 Copyright © 1992/1995 FLY'N THINGS™

COWL

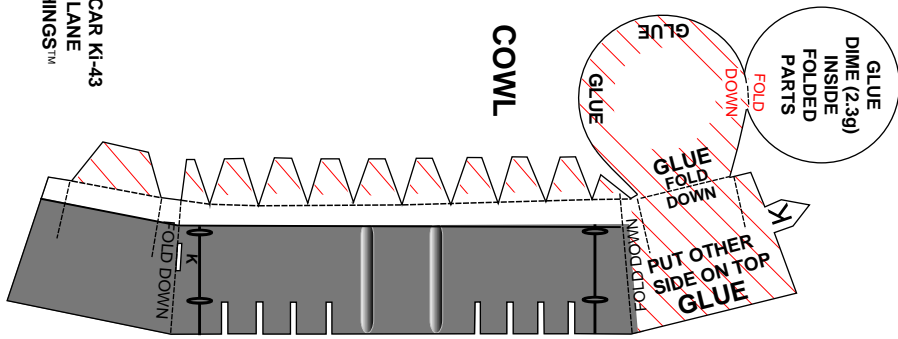

GLUE (2.3g)
 INSIDE
 FOLDED
 PARTS

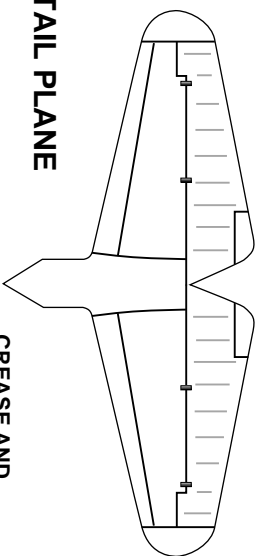

TAIL PLANE

CREASE AND
FOLD UNDER

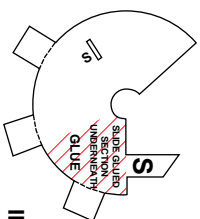
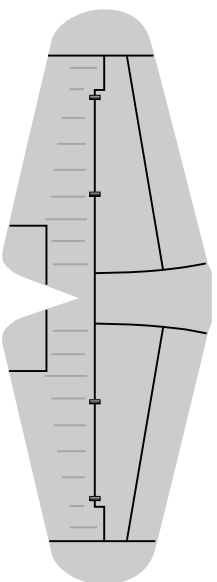

INSIDE
CONE

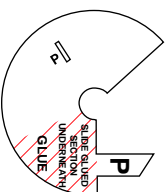

OUTSIDE
CONE

COCKPIT COVER

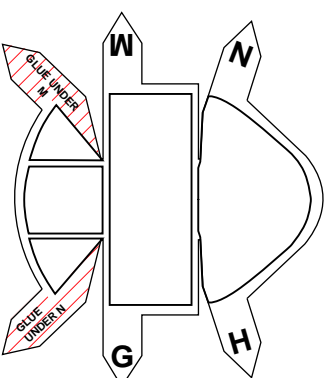

COWL TRIM

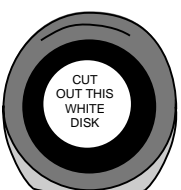

TRIM TO FINAL SIZE
AFTER ASSEMBLY
TO FRONT OF COWL

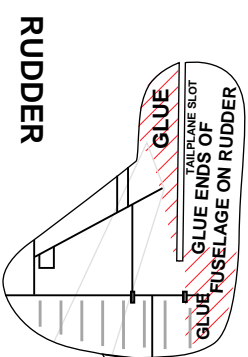

RUDDER

CREASE AND
FOLD UNDER

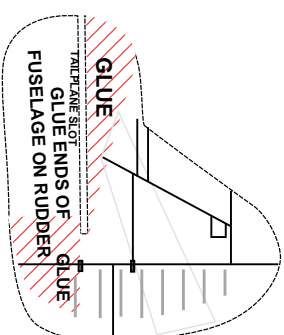

Released For Personal Use Only
All Commercial Rights Reserved
PKAeronaut@aol.com



WWJII JAPANESE NAKAJIMA OSCAR KI-43
DIME-WEIGHT FLYING MODEL PLANE
Copyright © 1992/1995 FLY'N THINGS™

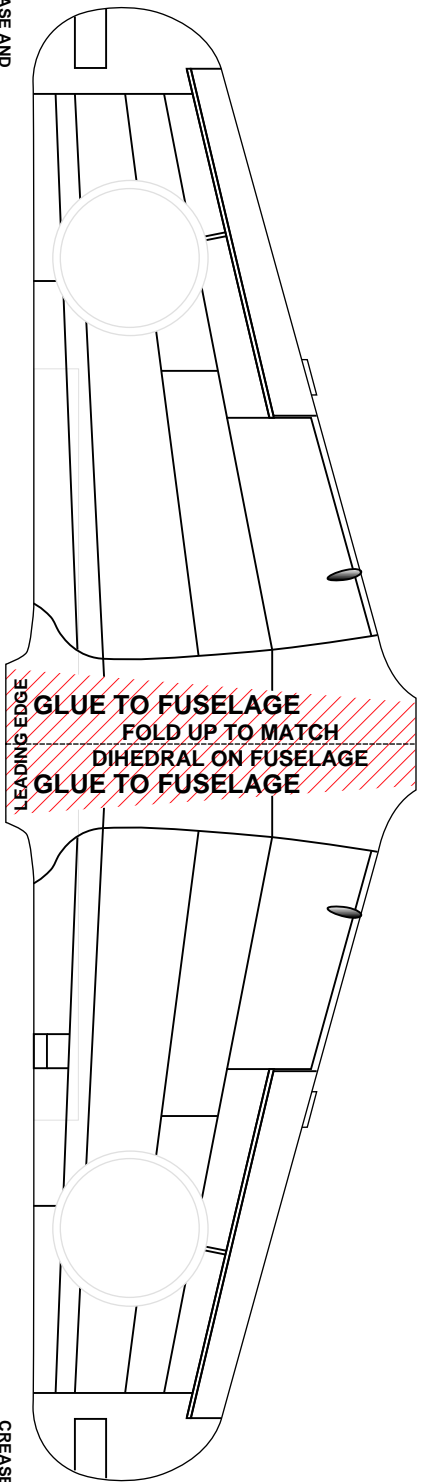

CREASE AND
FOLD UNDER

CREASE AND
FOLD UNDER

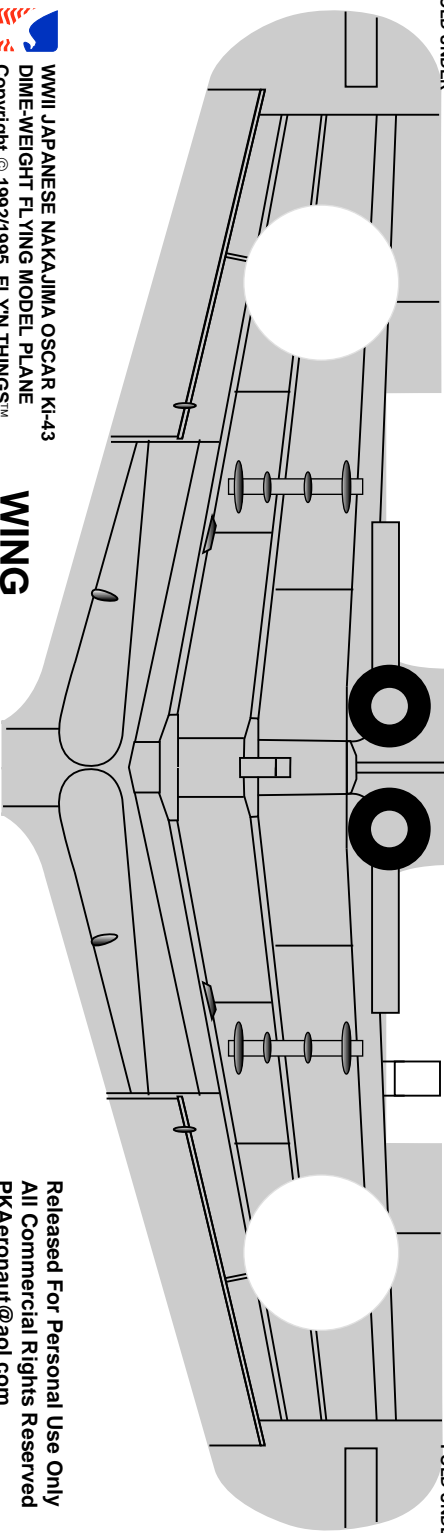

WWJ JAPANESE NAKAJIMA OSCAR KI-43
DIME-WEIGHT FLYING MODEL PLANE
Copyright © 1992/1995 FLYN THINGS™

WING

Released For Personal Use Only
All Commercial Rights Reserved
PKAeronaut@aol.com